

# Tecofi $\Phi$

VALVE MANUFACTURER - FRANCE

Armaturenhersteller

SEIT 1985

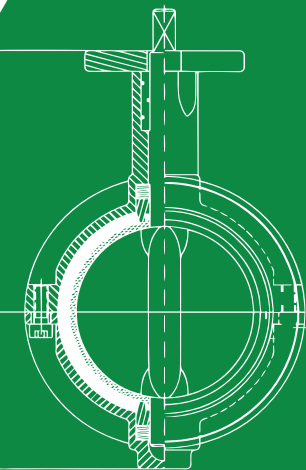

ERC  $\Phi$  CE

ISO 9001  
ISO 14001  
BUREAU VERITAS  
Certification



WRAS  
APPROVED PRODUCT

ACS



1985 in der Region Rhone-Alpes gegründet, wir konzipieren, fertigen und vertreiben seit mehr als 35 Jahre Industrielle Armaturen

# UNSER GESCHICHTE

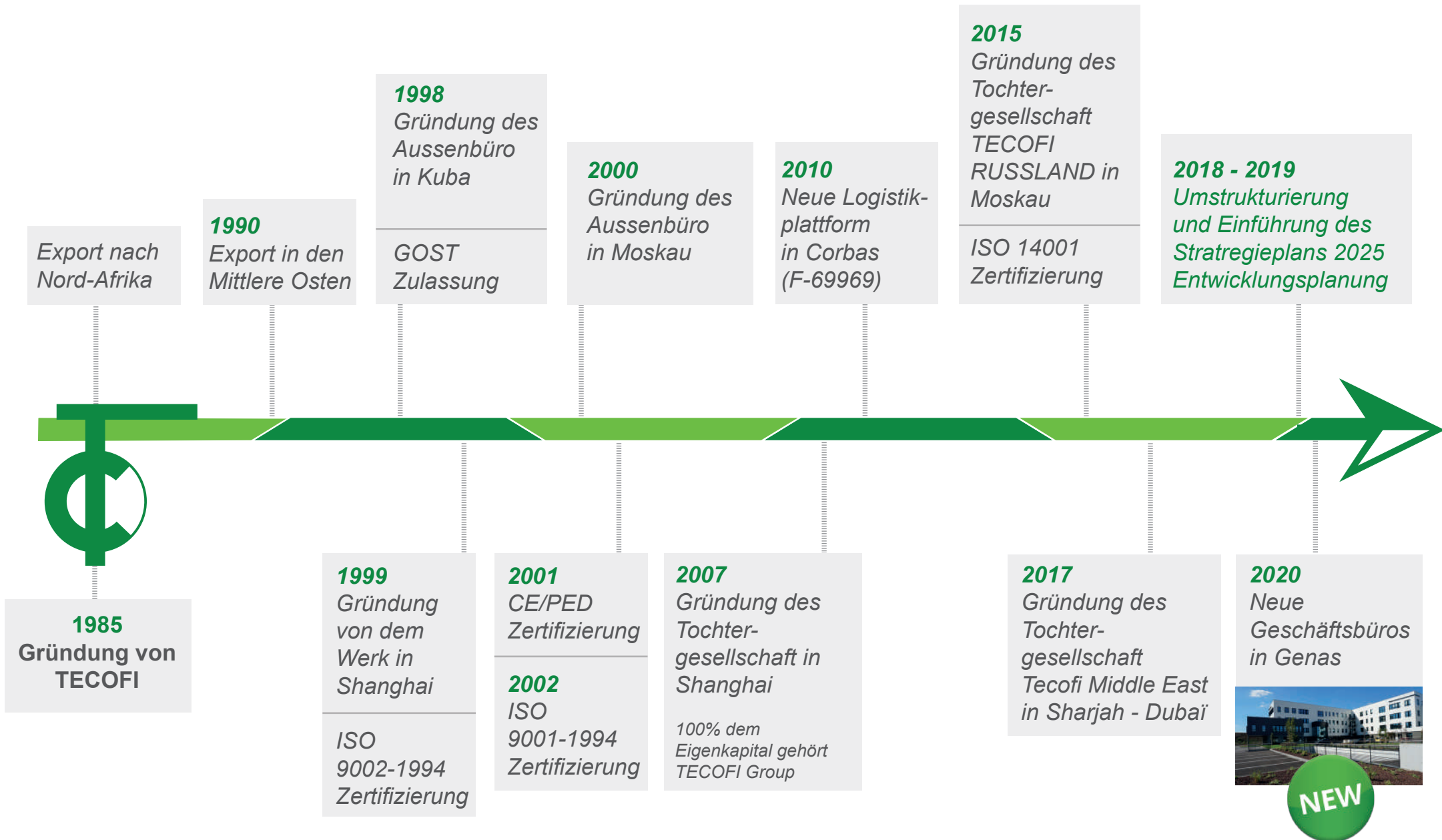

# //// ORGANIGRAMM TECOFI GROUP



GESCHÄFTSLEITUNG						
GESCHÄFTSFÜHRER <i>Jean-Paul COLOMBEL</i>				GENERALDIREKTOR <i>Fabien FAYARD</i>		
<b>Finanzvorstand</b> <i>Christelle MILLION</i>	<b>QS-Abteilungs- vorstand</b> <i>Franck SANCHEZ</i>	<b>Russland Geschäftsführer</b> <i>Serguei LOUTSKEVITCH</i>	<b>Marketingleiterin</b> <i>Céline SALVADO</i>	<b>Einkaufsleiter</b> <i>Jean-Charles VIRETTI</i>	<b>Versorgung- sleiterin</b> <i>Hayat AZOUAGH</i>	<b>Vertriebs- direktor</b> <i>David OUNDJIAN</i>

Weitere Abteilung		
> Personalabteilung	> Entwicklungsabteilung	> Einkauf
> Buchhaltung	> QS-Abteilung	> EDV
> Marketingabteilung	> Logistikabteilung	

**KUBA**  
Aussenbüro

Business Unit (Vertriebsabteilung)		
> Frankreich	> Afrika	> Asien
> Europa	> Russland	> Ozeanien
> Mittlerer Osten	> GUS / MOEL	> Kuba / Lateinamerika



**Geschäftsführer**  
*Serguei LOUTSKEVITCH*



**Geschäftsführer**  
*Sébastien CAULIER*



**Geschäftsführer**  
*Sébastien CAULIER*



**Geschäftsführer**  
*Shernan ALMIA*



## VIELFÄHIGKEIT

Die Reichhaltigkeit ist im Hertz unserer Alltagsarbeit. Unsere **Internationalität** und **Offenheit** bauen Tecofi ihre **kosmopolitische** Identität an. Wir arbeiten mit mehreren Partnern aus verschiedenen Kulturen.



## DYNAMISCH

Unsere **Ambition**, unsere **Flexibilität** und unserer **Mut** bilden unser **Wachstum mit Energie** aus. Immer im Bewegung, wir sind für alle **Gelegenheiten** offen und bringen jeden Tag eine neue **Herausforderung** an.



## MENSCHLICHKEIT

**Team Arbeit** ist ein Pfeiler unserer Unternehmenskultur, dank der internen **Geselligkeit**. Wir schenken allem unser **Vertrauen**, dass jedem in seiner Aufgabe sich zu **entwickeln** die Möglichkeit hat.

# //// UNSERE TRÜMPFE IM RICHTUNG KUNDENBEFRIEDENHEIT

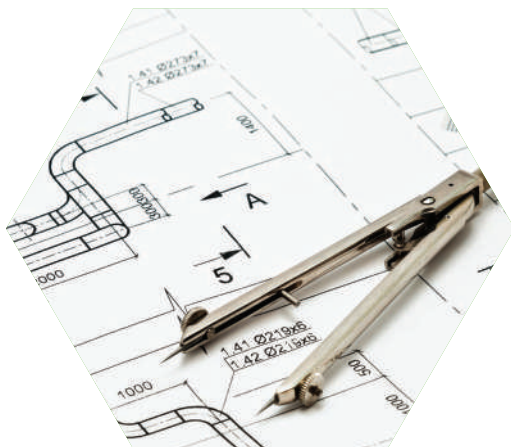

## ANPASSUNGS- FÄHIGKEIT

Maßarbeiten Lösungen empfehlen, nach alle Projekte gerichtet.

*Wir bieten, laut Bedürfnisse, personalisierte Angebote an und empfehlen maßarbeiten Lösungen.*



## BERATUNG

Eine technische Unterstützung anbieten.

*Unsere Fachpersonal begleiten alle Kunden Projektelang, von der Empfehlung bis Inbetriebsetzen.*



## ERFAHRUNG

Unsere Erfahrung für alle Projekte bringen

*Unsere mehr als 30 jährige Erfahrung im Bereich Industriearmaturen ermöglicht unsere Kunden mit Professionals zu arbeiten.*



## ZUFRIEDENHEIT

Kunden Zufriedenheit ist unsere Priorität.

*Wir alles einsetzen, um unsere Kunden die beste Dienste zu tun.*



UNSERE ENGAGEMENTS

**Tecofi'**  
VALVE DESIGNER - FRANCE



**La  
FRENCH  
FAB**

**LES INDUSTRIELS  
EN MOUVEMENT**

**WIR HABEN UNS DER FRENCH FAB BEWEGUNG  
ANGESCHLOSSEN, UM :**

- › die französische Industritransformation zu beschleunigen
- › die französische Industrie Erfolg und ihre Attraktivität zu verkörpern
- › die französische Industrie Exzellenz auf internationaler Basis

# //// UNSER EXPERTISEBEREICH



**WASSER | WASSERVERSOR-  
GUNG | WASSERWERKEN |  
BEWÄSSERUNGSSYSTEME**



**PAPIERBRANCHE**



**INDUSTRIE - Zuckerfabrik,  
Weinindustrie, Chemieindustrie,  
Nahrungsmittel, Zimentwerke**



**BIOGASANLAGE**



**LUFT- UND KÄLTE TECHNIK**



**MIENEN**



# //// TECOFI : FIRMENGRUPPE

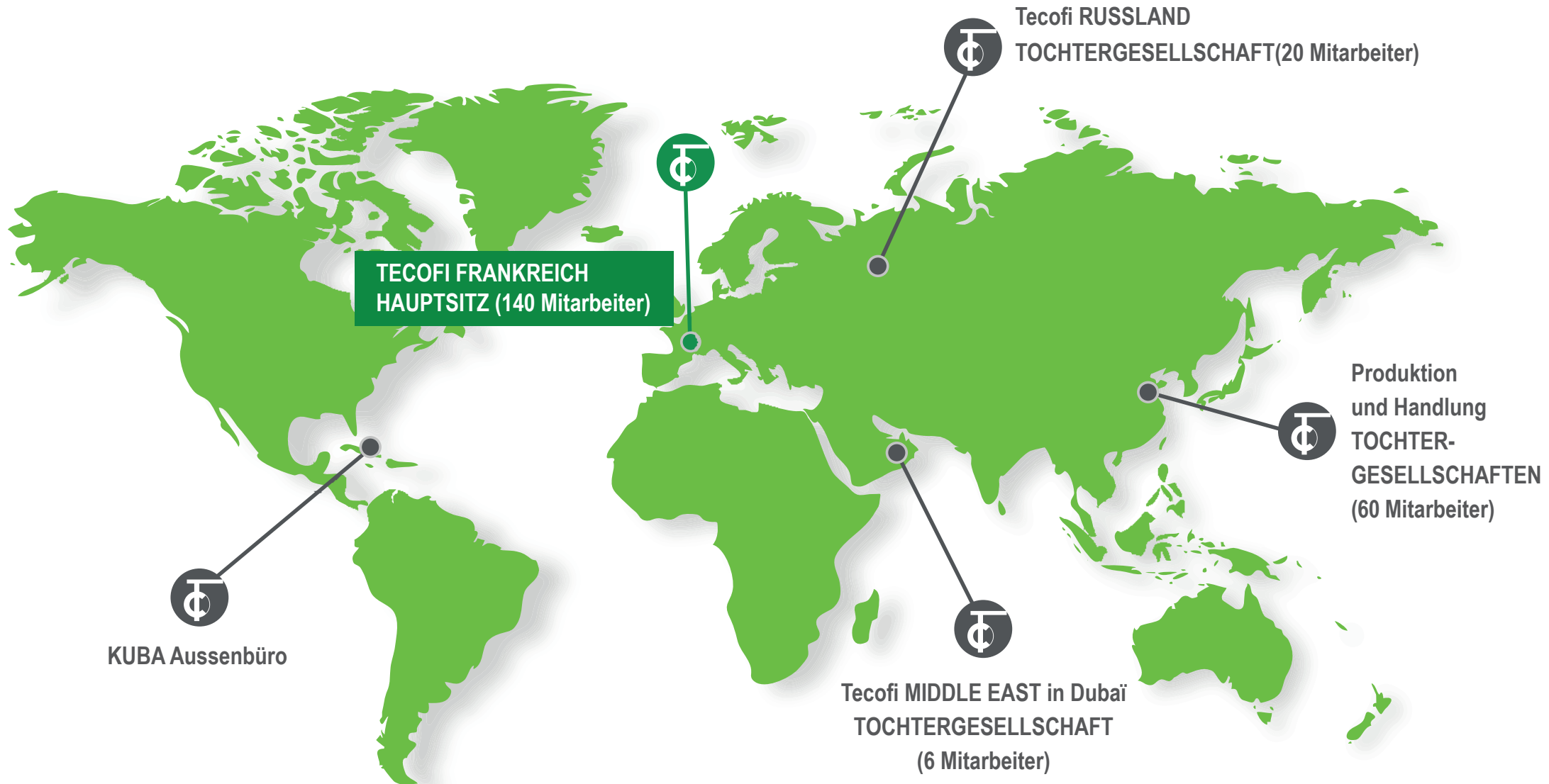

# HAUPTSITZ - LYON UMGEBUNG



**Tecofi**   
VALVE MANUFACTURER - FRANCE



1 500 m<sup>2</sup>  
Werkstatt

6 500 m<sup>2</sup>  
Lagerbestand



1 000 m<sup>2</sup>  
Büroräume

# //// GESCHÄFTSBÜRO



## TECOFI ZIEHT NACH GENAS IN DER REGION LYON.

Um unsere Kunden und Partner zu empfangen, unser "Team" weiter zu stärken, die Qualität des Arbeitslebens zu verbessern und alle unsere Verwaltungsteams zusammenzuführen, und Vertrieb in einem einzigen Gebäude unterzubringen, zieht Tecofi nach Genas um!

- > Das Gebäude wurde unter Einhaltung der höchsten Umweltauflagen gebaut (HQE zertifiziert)
- > Mit großen Räumen zum Arbeiten, Diskutieren und Entspannen

**1 500 m<sup>2</sup>  
Bürofläche**

**Räume für  
Empfänge**

**Das Gebäude  
ist als "grün"  
zertifiziert**



# //// PRODUKTIONSWERK



**Tecofi**   
VALVE MANUFACTURER - FRANCE

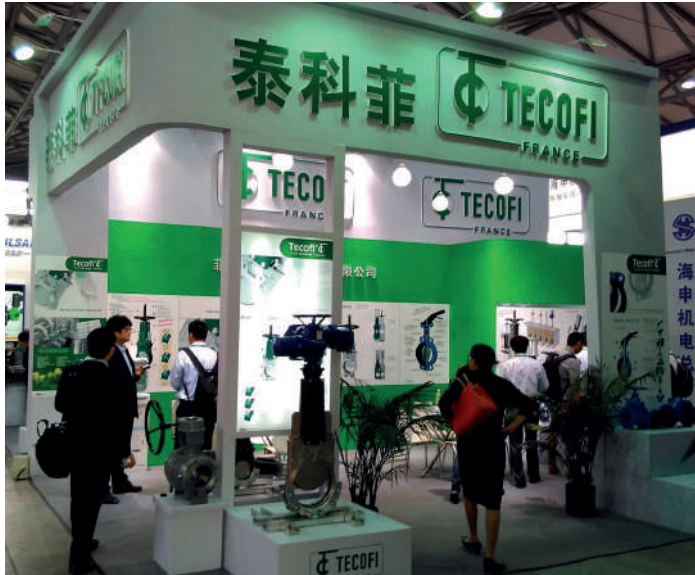

2 500 m<sup>2</sup>  
Produktion

1 500 m<sup>2</sup>  
Montagelinie  
& Lagerbestand



700 m<sup>2</sup>  
Bürräume

# //// TOCHTERGESELLSCHAFT - RUSSLAND

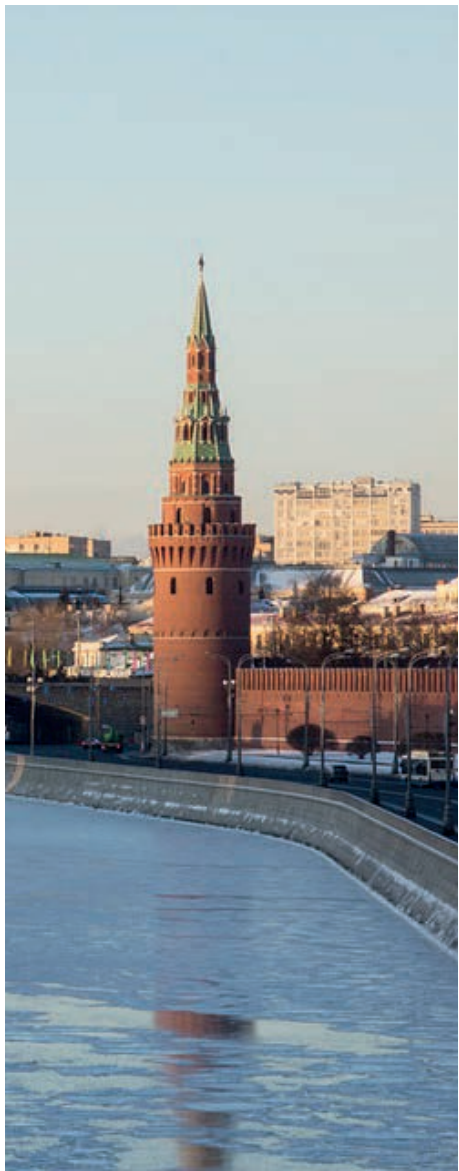

# //// TOCHTERGESELLSCHAFT - DUBAI



# //// KUBA AUSSENBÜRO



# //// TECOFI GROUP IN ZAHLEN



**+250**

Mitarbeiter



**40**

Millionen Euro  
Umsatz



**70 %**

Aller der Aktivitäten  
im Exportgeschäft



**+35**

Jahre Erfahrung



# //// TÄTIGKEITSFELDER

*Als französischer Hersteller entwickeln, produzieren und vertreiben wir eine komplette Produktpalette von Klappen, Schiebern und viele weitere Produkte im Bereich der Industriearmaturen.*

Design des Ventils in Frankreich



Produktionsstart in der TECOFI-Fabrik

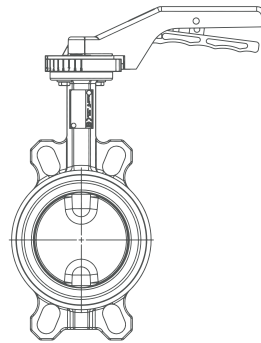

Materialinspektion in der TECOFI-Fabrik



Versand nach Lyon



Zusammenbau in der Tecofi-Fabrik in Lyon



Test und Inspektion mit dem Kunden



Versand an den Kunden

## INNOVATIONEN EINFÜHREN UND MEISTERN DES PRODUKTIONSPROZESSES

Unsere Entwicklungsabteilung arbeitet täglich mit  
unserem Werk zusammen.

- Bleit immer auf die technische Entwicklung  
aufmerksam um die Produkte zu verbessern und  
die Produktpalette weiter zu entwickeln.
- Entwickelt auf den Kunden zugeschnittene Lösungen

Die F&E Abteilung benutzt als Software 3D  
SolidWorks und Simulation Software um die  
Endprodukte darzustellen.



# //// PRODUKTION & TESTS

➤ **Produktion in eigenen Werken.**

Unser Markenname und die Artikelreferenz stehen auf alle Ventilen

➤ Von der Giesserei bis hin zum Beschichtungsprozess, werden die **Ventile in allen Stufen getestet** (Gehäuse- Bearbeitungs- sowie Betriebsdruckkontrolle).

➤ Unsere Produktionsstätten werden **regelmässig** von einer unabhängigen Firma sowie unserer QS-Abteilung auditiert.



Entwicklung und Produktion werden entsprechend aller relevanten Normen, nationaler und internationaler Spezifizierungen umgesetzt.



# //// QUALITÄTSKONTROLLE



Die straffe Kontrollverfahren werden gemäss internationaler Normen durchgeführt.

**WARENKONTROLLE**

**HYDRAULISCHE  
DICHTIGKEITSKONTROLLE**

**DIMENSIONKONTROLLE**

**BETRIEBSKONTROLLE**

**KONTROLLE DER  
SCHICHTDICKE**

TECOFI  
FÜHRT DIE  
SCHICHTDICKE  
LAUT DER NORM  
EN12266-1 DURCH.



# //// NEUE ARMATURENPRÜFSTÄNDE

## NOUVEAUTÉ 2021

Zwei neue hydraulische Prüfstände lassen uns ermöglichen die Durchführung von Tests an unseren Absperrklappen von DN50 bis DN1600.

Die Tests werden gemäß der Norm EN12266-1 durchgeführt.

NEW



*Alle unsere Ventile werden zu 100% auf Druck getestet.  
von 1,5 x PS für den Körper und 1,1 x PS für den Sitz.*

Wir garantieren Produkte mit hohem Qualitätsniveau, die nach den allerletzten europäischen Normenentwicklungen hergestellt werden.

Die QS-Abteilung erstellt die Zertifikate und Prüfzeugnisse laut Systemanforderungen.



## > ISO 9001 - 2015

Diese Zertifizierung für den Bereich «Armaturentwicklung, Montage und Handlung» identifiziert TECOFI als offiziellen Produzenten im Bereich Industriearmaturen.

## > ISO 14001 - 2015

Die ISO 14001-2015 Zertifizierung wurde durch ein aktives Umweltmanagementsystem erlangt.

*«Als einer der Hauptakteure auf dem Beschaffungsmarkt der Wasserarmaturen ist diese Zertifizierung unumgänglich. Wie auch unsere Kunden müssen wir vorbildlich sein im Punkto Umwelt».*



## > EUROPÄISCHE WEISUNGEN



- **PED / DESP** : Unsere Produkte entsprechen der Europäische Richtlinien 2014/68/UE

- **EX** : Unsere Produkte entsprechen der Richtlinie Ex 2014/34/UE «explosionsfähige Atmosphäre».

- **Maschinen Richtlinien** : Unsere Produkte entsprechen der Maschinen Richtlinie 2006/42/CE.

## > WASSER ZERTIFIZIERUNGEN



## > ZUSÄTZLICHE ZERTIFIZIERUNGEN :





# //// MONTAGE UND UMRÜSTUNG



## 5 MONTAGE LINIEN

**Besondere Montagen werden in Corbas (Frankreich) gemacht.**

*Anpassungen und Einstellungen von Motoren (E-Antriebe, pneumatische Antriebe), Endschalter, ...*



# //// MONTAGE UND INDIVIDUELLE ANPASSUNGEN



*Kugelhähne PN100 mit doppelwirkendem pneumatischen Antrieb und Not-Handrad*

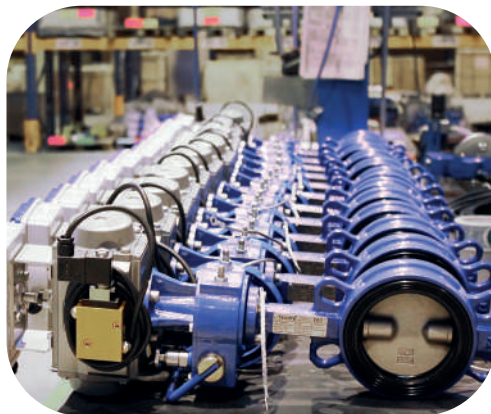

*Absperrklappe mit doppelwirkendem pneumatischen Antrieb, Not-Handrad und Magnetventile*

**Wir realisieren alle Montage-Arten :**  
Magnetventile, elektronische und pneumatische Antriebe, spezielle Dichtungen, Stellgerät, mechanische und induktive Endschalter...



# //// GROSSER LAGERBESTAND, SCHNELLE LIEFERUNG

Mit 6500m<sup>2</sup> Lagerfläche, besitzt Tecofi einen dicken Produktbereich bis DN1200.



Ein beherrschter Produktfluss und internationaler Transport, sowie die Reaktivität unserer Versandabteilung ermöglicht es uns unsere Kunden sehr schnell zu beliefern (national sowie international)



Das Team unserer Wartungstechniker gewährleistet die on-site Instandhaltung und Schulungen.



# //// UNSERE PRODUKTE



ABSPERRKLAPPEN, SCHIEBERPLATTEN,  
KEILSCHIEBER, KLAPPEN, KOMPENSATOREN ...



## **DIE ABSPERRKLAPPE UNSER BESTSELLER**



# //// PRODUKTPALETTE DER ABSPERRKLAPPEN

**Tecofi**   
VALVE MANUFACTURER - FRANCE



# //// PRODUKTPALETTE DER ABSPERRKLAPPEN

**Tecofi**  $\Phi$   
VALVE MANUFACTURER - FRANCE

**TecFly**  
Concentric Butterfly Valve







## DIE PLATTENSCHIEBER

### UNSERE DNA



# //// PRODUKTPALETTE DER PLATTENSCHIEBER

**Tecofi**   
VALVE MANUFACTURER - FRANCE

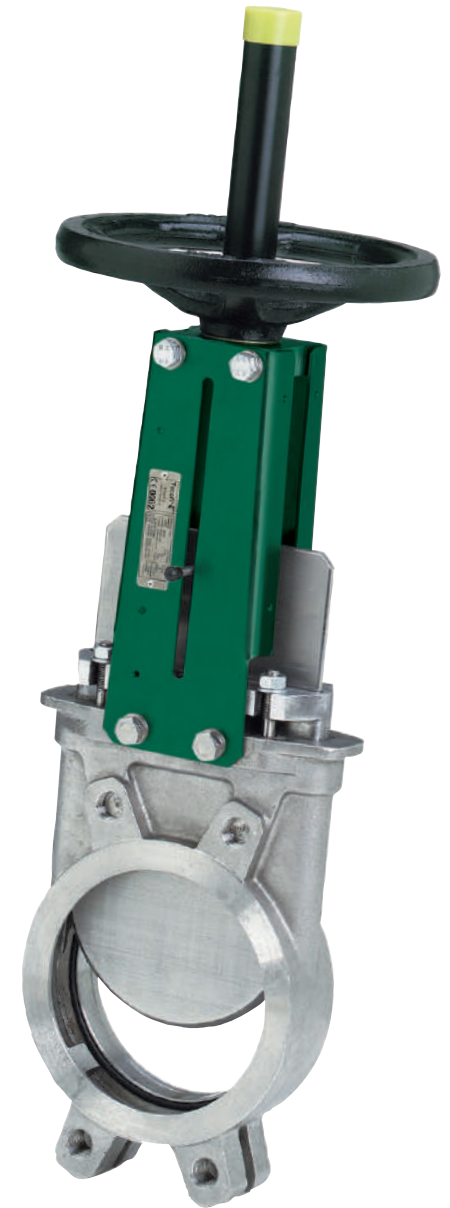
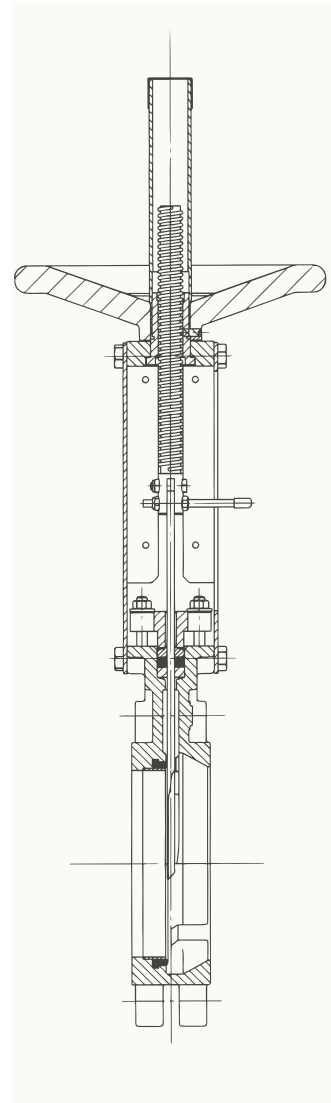
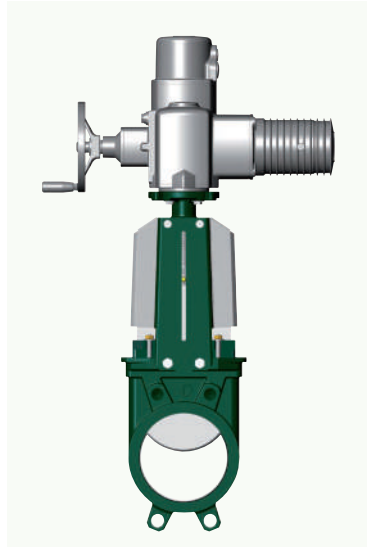

# //// PRODUKTPALETTE DER PLATTENSCHIEBER

**Tecofi**   
VALVE MANUFACTURER - FRANCE



**TecKnife**  
Knife Gate Valve

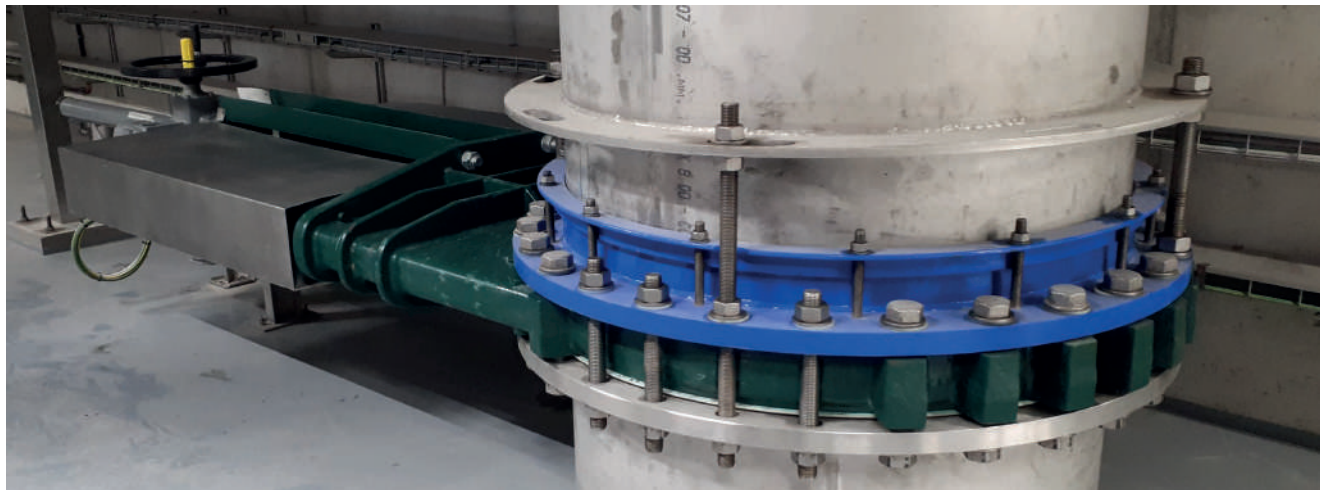
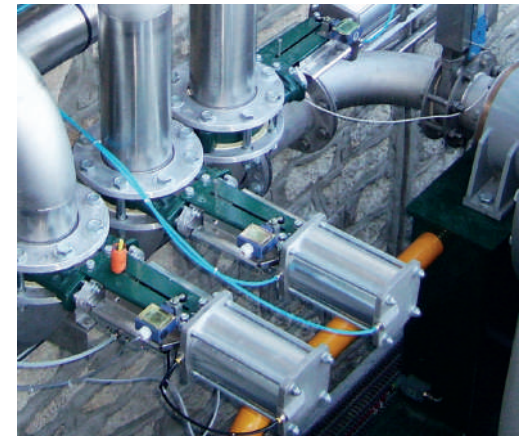

# //// MASSGESCHNEIDERTE PRODUKTE FÜR JEDEN MARKT

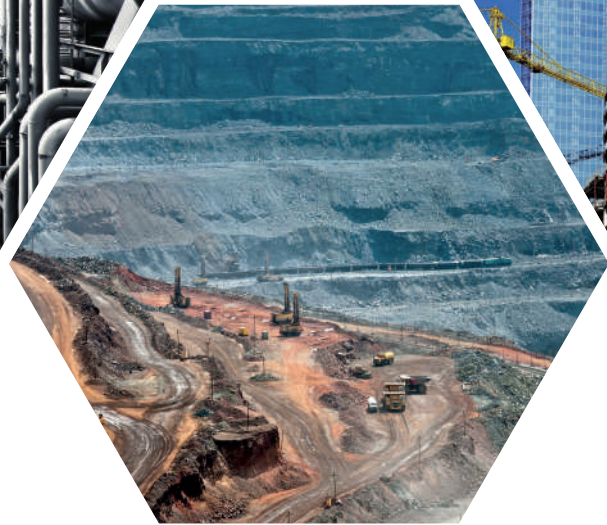



# WASSER | WASSERVERSORGUNG | PUMPENSYSTEME | BEWÄSSERUNG

· Absperrklappen

· Be- und Entlüftungsventile

· Ausbaustücke

· Ablassventile

· Klappen

· Schmutzfänger

· Absperrschieber

· Plattenschieber

· Instrumentarien

· Kugelhähne

· Verbindungen



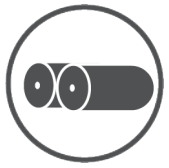

# PAPIERBRANCHE

**Tecofi**   
VALVE MANUFACTURER - FRANCE

## Absperrklappen

*Hohebetriebsleistung, mit  
Manchette, Zwischenflansche...*

## Plattenschieber

*Gusseisern, voll Edelstahl, mit  
Handrad, pneumatische Zylinder,  
bidirektional, mit durchgehender  
Platte...*





# INDUSTRIE

· Kompensatoren

· Kugelhähne

· Instrumentarien

· Absperrschieber

· Regelventile

· Sicherheitsventile

· Absperrklappen

· Schieberplatten

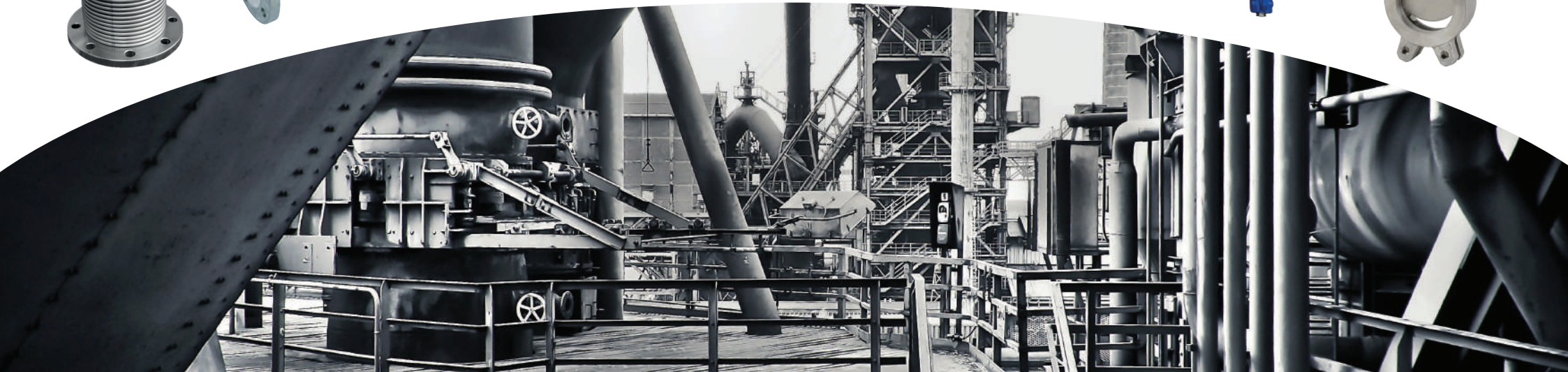



# BIOGASANLAGEN

· Kompensatoren

· Kugelhähne

· Absperrklappen

· Absperrschieber

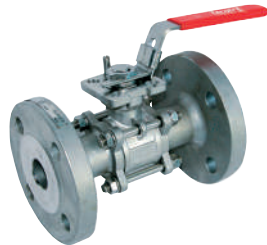





# LUFT- UND KÄLTE TECHNIK

**Tecofi**   
VALVE MANUFACTURER - FRANCE

Keilschieber

Absperrklappen

Regulierventile

Bronzeventile

Kompensatoren

Zubehör





# MIENEN

**Tecofi**   
VALVE MANUFACTURER - FRANCE

Spezielle Pinchventile für  
Schleifmittel

Absperrklappen  
Pinchventile

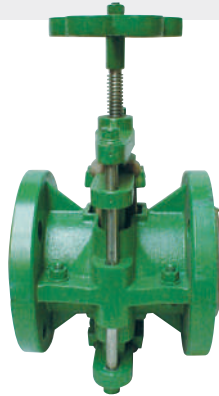

# //// UNSERE STÄRKEN



*Eine internationale  
und dynamische  
Firma*



*Experten  
know-how seit  
mehr als 35  
Jahren*



*Fachkundige  
und motivierte  
Mitarbeiter*



*kunden- und  
projektorientierte  
Spezialisten*

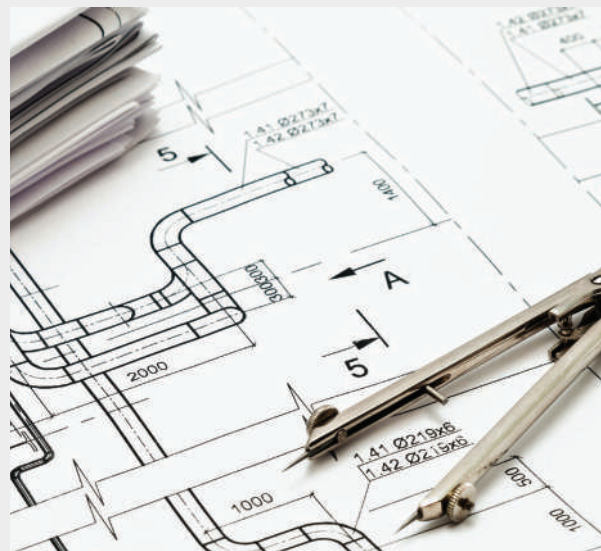

# //// EINIGE UNSERER REFERENZEN



## > KLÄRANLAGEN

· **Modernisierungsprojekt  
einer Kläranlage  
Belgien**

· Lieferung von  
· Absperrklappen,  
· Plattenschiebern,  
· Kugelhäne, Kugel-  
· Rückschlagventile

## > WASSERVERSORGUNG

· **Wasserfiltration der  
Springbrunnen in den  
Burj Khalifa Türmen  
Dubai**

· Lieferung der  
· Schmutzfänger unter  
· den Springbrunnen.

## > BIOGASANLAGE

· **Ventile für  
Methanisierungsprozess  
Schweiz**

· Lieferung von  
· Plattenschieber.

# //// EINIGE UNSERER REFERENZEN



## > WEININDUSTRIE

Plattenschieber für  
Weinproduktion  
Frankreich

Lieferung von einseitig-  
und bidirektionalen  
Plattenschiebern

## > WASSERAUFBEREITUNG

*Vietnam*

Lieferung von  
Plattenschiebern,  
Absperklappen, Kugel-  
und Rückschlagventile...

## > WASSERWERKE

*Afrika*

Lieferung von Tecwat mit  
E-Antrieb.

## Was von uns gesagt wird :

### Regelmässiger Lieferant

TECOFI ist für uns ein regelmäßiger Lieferant in zahlreichen Projekten und gehört zu unseren bevorzugten Ventil-Lieferanten.



### Sicherer Handelspartner

TECOFI ist einer der Hauptlieferanten im Wasserbereich

Abgesehen vom guten Preis-Leistungs-Verhältnis ist TECOFI ein zuverlässiger Partner, der für die Qualität seiner Produkte anerkannt ist. TECOFI hat einen exzellenten Kundendienst.

Wir empfehlen den Lieferanten uneingeschränkt für seinen Service und die Qualität.

TECOFI ist reaktives und proaktives Kleinunternehmen, das schnell auf seine Kunden eingeht.



**DANKE FÜR  
IHRE AUFMERKSAMKEIT**



# Tecofi

VALVE MANUFACTURER - FRANCE



## Lager

83, rue Marcel Mérieux  
69960 Corbas - FRANCE

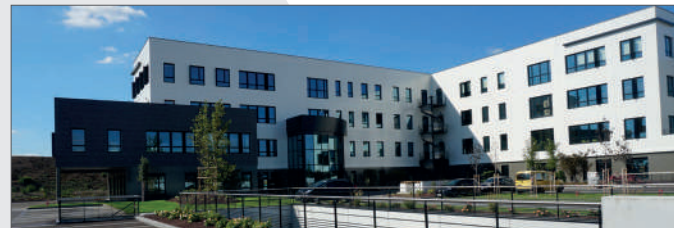

## Geschäftsbüro

ZAC EverEst Parc  
8, Rue Joseph Nicéphore Niépce  
69740 GENAS

T. +33 (0)4 72 79 05 79 |  +33 (0)4 78 90 19 19  
 sales@tecofi.fr |  WhatsApp CHAT +33 623 898 706

[www.tecofi.fr](http://www.tecofi.fr)