



# CLAPET | FILTRE CHECK VALVE | STRAINER

**CLAPETS AXIAUX**  
AXIAL CHECK VALVES

162 > 168

**CLAPETS À BOULE**  
BALL CHECK VALVES

169 > 170

**CLAPETS À BATTANT**  
SWING CHECK VALVES

171 > 177

**CLAPETS À SOUPAPE**  
LIFT CHECK VALVES

178

NEW

**CLAPETS D'EXTREMITÉ**  
TERMINAL CHECK VALVES

179

**CLAPETS À PAPILLON**  
TILTING CHECK VALVES

180

**DISCONNECTEURS**  
BACKFLOW  
PREVENTERS

181

**CONSEILS TECHNIQUES**  
TECHNICAL NOTES

182 > 184

**FILTRES**  
STRAINERS

185 > 191

NEW

**FILTRES À PANIER**  
BASKET STRAINERS

192

**BOÎTES À BOUE**  
FLANGED H-STRAINERS

193

# CLAPET DE NON RETOUR À FERMETURE RAPIDE

## QUICK-CLOSING NON-RETURN CHECK VALVE

NEW



Clapet de haute qualité à faible inertie pour assurer la sécurité de vos réseaux d'eau.

High quality, low inertia check valve to secure your water networks.



ACS



- ✓ Minimise les coups de bélier - **Excellente réponse dynamique**  
*Prevents water hammer - Excellent dynamic solution*
- ✓ Fonctionne en toutes positions d'installation : ressort inox de rappel  
*Used in all installation positions: Stainless steel counter spring*
- ✓ Excellent comportement hydraulique : faibles pertes de charge  
*Optimum hydraulic operation: low pressure loss (optimal flow)*
- ✓ Manoeuvre silencieuse - Absence de vibration  
*Operates silently - No vibration*
- ✓ Étanchéité 100% en position fermée  
*100% sealing in closed position*
- ✓ Absence de maintenance de part sa conception  
*No maintenance due to its design (no seat gasket, no obturator wear)*
- ✓ Robuste et résistant : corps et anneau en fonte ductile GGG40  
Ressort Inox 302 | *Robust and resistant: body and ring in ductile iron GGG40 - Stainless steel spring 302*
- ✓ Revêtement époxy ACS épaisseur minimum 250microns  
*Epoxy coating minimum thickness 250microns*
- ✓ Certifié ACS pour eau potable  
*ACS certification for potable water*



### Conception Innovante

- ✓ Obturateur léger et de faible inertie (course limitée à 1/10 du diamètre nominal).
- ✓ Obturateur en polyuréthane qui absorbe les chocs.
- ✓ Absence de pièce mécanique.
- ✓ Profil hydraulique permettant un écoulement optimal.
- ✓ Gamme unique : raccordement entre-brides PN10/16/25/40/ASA150/ASA300.

### Innovative design

- ✓ Light-weight obturator with low inertia (short operation travel limited to 1/10th of nominal diameter).
- ✓ Obturator made of polyurethane to absorb the shocks.
- ✓ No mechanical parts.
- ✓ Hydraulic design allowing optimal flow.
- ✓ Unique range: wafer type for PN10/16/25/40/ASA150/300 flanges.

### CA4460

Clapet de non retour à fermeture rapide entre brides PN10-16-25-40-ASA150-ASA300  
Quick-closing non-return valve PN10-16-20-25-40-ASA150-ASA300



Corps : Fonte ductile EN-GJS-400-15 (GGG40)  
Anneau : Fonte ductile EN-GJS-400-15 (GGG40)  
Obturateur : Polyuréthane  
Ressort : Inox 302  
Étanchéité : SBR  
Raccordement : Entre brides PN10, PN16, PN25, PN40, ASA150, ASA300  
Pression de service max : 40 bar  
Température de service max : +60°C

Body: Ductile iron EN-GJS-400-15 (GGG40)  
Ring: Ductile iron EN-GJS-400-15 (GGG40)  
Obturator: Polyurethane  
Spring: Stainless steel 302  
Seal: SBR  
Connection: Between flanges PN10, PN16, PN25, PN40, ASA150, ASA300  
Maximum working pressure: 40 bar  
Maximum working temperature: +60°C

ACS



**Gamme unique et complète**  
**PN10/16/25/40/ASA150/ASA300**  
**One single and complete range**  
**PN10/16/25/40/ASA150/ASA300**

DN	L (mm)		Kg	Ref.
	mm	inch		
50	2"	50	1	CA4460-0050
65/80	3"	80	2	CA4460-0080
100	4"	100	6	CA4460-0100
125	5"	125	11	CA4460-0125
150	6"	150	17	CA4460-0150
200	8"	127	22	CA4460-0200
250	10"	146	35	CA4460-0250
300	12"	181	50	CA4460-0300
350	14"	222	80	CA4460-0350
400	16"	232	100	CA4460-0400
450	18"	260	135	CA4460-0450
500	20"	292	180	CA4460-0500

CA4200 | CA4240 | CA4250 | CA4260

Clapet de non retour à fermeture rapide à brides grand DN ACS

Quick-closing non-return valve, large sizes ACS



Corps : Fonte ductile EN-GJS-400-15 (GGG40)  
 Anneau : Fonte ductile EN-GJS-400-15 (GGG40)  
 Obturateur : Elastomère de polyuréthane  
 Ressort de compression : Inox 302  
 Étanchéité : SBR  
 Raccordement : À brides PN10; PN16; PN25; PN40  
 Pression de service : 10/16/20/25/40 bar  
 Température de service max : +60°C  
 Prix sur demande  
 ASA 150 / 300 sur demande

Body: Ductile iron EN-GJS-400-15 (GGG40)  
 Ring: Ductile Iron EN-GJS-400-15 (GGG40)  
 Obturator: Polyurethane  
 Spring: Stainless steel 302  
 Seal: SBR  
 Connection: Flanged PN10; PN16; PN25; PN40  
 Working pressure: 10/16/20/25/40 bar  
 Maximum working temperature: +60°C  
 Prices on request  
 ASA 150/300 on request



DN		L (mm)	Kg*	PN10	PN16	PN25	PN40
mm	inch			Ref.	Ref.	Ref.	Ref.
600	24"	435	500	CA4200-0600	CA4240-0600	CA4250-0600	CA4260-0600
700	28"	500	800	CA4200-0700	CA4240-0700	CA4250-0700	CA4260-0700
800	32"	515	1000	CA4200-0800	CA4240-0800	CA4250-0800	CA4260-0800
900	36"	710	1700	CA4200-0900	CA4240-0900	CA4250-0900	CA4260-0900
1000	40"	730	1900	CA4200-1000	CA4240-1000	CA4250-1000	CA4260-1000
1200	48"	900	3400	CA4200-1200	CA4240-1200	CA4250-1200	CA4260-1200

\*susceptible de changement, DN supérieurs sur demande / change possible, other DN on request

Clapet de non retour à fermeture rapide à brides grand DN NON ACS

Quick-closing non-return valve, large sizes NON ACS

DN		L (mm)	Kg*	PN10	PN16	PN25	PN40
mm	inch			Ref.	Ref.	Ref.	Ref.
600	24"	435	500	CA4200A-0600	CA4240A-0600	CA4250A-0600	CA4260A-0600
700	28"	500	800	CA4200A-0700	CA4240A-0700	CA4250A-0700	CA4260A-0700
800	32"	515	1000	CA4200A-0800	CA4240A-0800	CA4250A-0800	CA4260A-0800
900	36"	710	1700	CA4200A-0900	CA4240A-0900	CA4250A-0900	CA4260A-0900
1000	40"	730	1900	CA4200A-1000	CA4240A-1000	CA4250A-1000	CA4260A-1000
1200	48"	900	3400	CA4200A-1200	CA4240A-1200	CA4250A-1200	CA4260A-1200

\*susceptible de changement, DN supérieurs sur demande / change possible, other DN on request

**ASSUREZ LA SÉCURITÉ DE VOS RÉSEAUX D'EAU !**  
**ENSURE THE SECURITY OF YOUR WATER NETWORKS!**

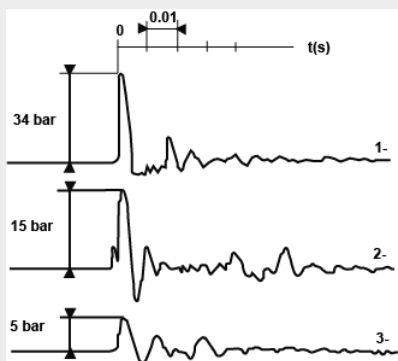

**Excellente réponse dynamique**  
*Excellent dynamic response*

Exemple d'enregistrements de la surpression durant la fermeture de plusieurs types de clapets de non-retour, dans les mêmes conditions de fonctionnement.

*Sample of overpressure records taken during water hammer tests of various types of check valves operating under identical conditions.*

- 1 - Clapet à simple battant (wafer swing check valve)
- 2 - Clapet double battant (dual plate check valve)
- 3 - Clapet à fermeture rapide TECOFI CA4460, CA4240, CA4250, CA4260 (TECOFI quick-closing check valve)



**CLAPETS AXIAUX**  
AXIAL TYPE CHECK VALVES

**CA1103**

Clapet axial laiton femelle BSP "toutes positions"

All position female BSP check valve



Corps : Laiton CW617N  
Clapet : ABS  
Ressort : Inox  
Étanchéité : Nitrile  
Raccordement : Femelle / Femelle BSP  
Pression de service : 16 bar  
Température de service : -20°C/+100°C

Body: Brass CW617N  
Disc: ABS  
Spring: Stainless steel  
Seal: Nitrile  
Connection: Female / Female BSP  
Working pressure: 16 bar  
Working temperature: -20°C/+100°C

**JUSQU'À ÉPUISEMENT DES STOCKS**  
WHILE STOCKS LAST

DN		L (mm)	Kg	Ref.
mm	inch			
15	1/2"	45	0,12	CA1103-0015
20	3/4"	48	0,18	CA1103-0020
25	1"	54,5	0,24	CA1103-0025
32	1"1/4	58	0,33	CA1103-0032
40	1"1/2	65,5	0,50	CA1103-0040
50	2"	71,5	0,70	CA1103-0050

**CC1142**

Clapet crépine femelle BSP "toutes positions"

Female BSP all position foot type check valve



Corps : Laiton  
Clapet : Nylon  
Étanchéité : Nitrile  
Crépine : Inox 304  
Raccordement : Femelle / Femelle BSP  
Pression de service : 8 à 16 bar  
Température de service : 0°C/+65°C

Body: Brass  
Disc: Nylon  
Seal: Nitrile  
Strainer: Stainless steel 304  
Connection: Female / Female BSP  
Working pressure: 8 to 16 bar  
Working temperature: 0°C/+65°C

**JUSQU'À ÉPUISEMENT DES STOCKS**  
WHILE STOCKS LAST

DN		L (mm)	Kg	Ref.
mm	inch			
15	1/2"	34,5	0,10	CC1142-0015
20	3/4"	42	0,12	CC1142-0020
25	1"	47,5	0,16	CC1142-0025
32	1"1/4	59,5	0,22	CC1142-0032
40	1"1/2	71	0,33	CC1142-0040
50	2"	86,5	0,5	CC1142-0050
65	2"1/2	102	1,02	CC1142-0065
80	3"	125	1,35	CC1142-0080
100	4"	155	1,85	CC1142-0100

**CA1142**

Clapet axial laiton femelle BSP "toutes positions"

Female BSP all position axial type check valve



Corps : 2 pièces Laiton CW617N  
Obtuteur : Nylon  
Ressort : Acier Inoxydable  
Étanchéité : Nitrile  
Raccordement : Femelle / Femelle BSP  
Pression de service : 16 bar  
Température de service : -20°C/+100°C

Body: 2-piece Brass CW617N  
Disc: Nylon  
Spring: Stainless steel  
Seal: Nitrile  
Connection: Female / Female BSP  
Working pressure: 16 bar  
Working temperature: -20°C/+100°C

**NEW**

**(ACS)** En cours / In progress

DN		L (mm)	Kg	Ref.
mm	inch			
15	1/2"	46,5	0,11	CA1142-0015
20	3/4"	50	0,16	CA1142-0020
25	1"	57	0,21	CA1142-0025
32	1"1/4	60,5	0,33	CA1142-0032
40	1"1/2	71	0,52	CA1142-0040
50	2"	74,5	0,74	CA1142-0050
65	2"1/2	100	1,14	CA1142-0065
80	3"	109,5	1,71	CA1142-0080
100	4"	114	3,10	CA1142-0100

**CC1142A**

Clapet crépine femelle BSP "toutes positions"

Female BSP all position foot type check valve



Corps : Laiton  
Clapet : Nylon  
Étanchéité : Nitrile  
Crépine : Inox 304  
Raccordement : Femelle / Femelle BSP  
Pression de service max : 16 bar  
Température de service : -20°C/+100°C

Body: Brass  
Disc: Nylon  
Seal: Nitrile  
Strainer: Stainless steel 304  
Connection: Female / Female BSP  
Maximum working pressure: 16 bar  
Working temperature: -20°C/+100°C

**NEW**

DN		L (mm)	Kg	Ref.
mm	inch			
15	1/2"	67,3	0,075	CC1142A-0015
20	3/4"	78,5	0,11	CC1142A-0020
25	1"	90	0,14	CC1142A-0025
32	1"1/4	102	0,22	CC1142A-0032
40	1"1/2	117,5	0,36	CC1142A-0040
50	2"	134,5	0,52	CC1142A-0050

**CR3201 | CR6146**

Crépines Inox pour clapet

Stainless steel screens for check valves



Matière CR3201 : Inox 316  
Matière CR6146 : Inox 304 + bague fileté en Nylon  
Raccordement : Mâle BSP

Material CR3201: Stainless steel 316  
Material CR6146: Stainless steel 304 + Nylon male threaded  
Connection: BSP male

**NEW**

**(ACS)** En cours / In progress

DN		Ref.
mm	inch	
10	3/8"	CR3201-0010
15	1/2"	CR3201-0015 CR6146-0015
20	3/4"	CR3201-0020 CR6146-0020
25	1"	CR3201-0025 CR6146-0025
32	1"1/4	CR3201-0032 CR6146-0032
40	1"1/2	CR3201-0040 CR6146-0040
50	2"	CR3201-0050 CR6146-0050
65	2"1/2	CR3201-0065 CR6146-0065
80	3"	CR3201-0080 CR6146-0080
100	4"	CR3201-0100 CR6146-0100

CA1102

Clapet anti-pollution femelle BSP  
Female BSP threaded antipollution check valve

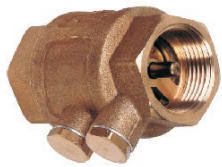

Corps : Laiton CW617N brossé  
Disque : Inox 304  
Étanchéité : Joint FKM  
Raccordement : Femelle BSP  
Pression de service max :  
Du 3/8" au 1" 25 bar  
Du 1"1/4 au 2" 18 bar  
Température de service max. :  
-10°C/+100°C  
Avec bouchon de purge amont et aval

Body: CW617N Brass  
Disc: Inox 304  
Seal: FKM  
Connection: female BSP  
Maximum working pressure:  
3/8" to 1" 25 bar  
1"1/4 to 2" 18 bar  
Maximum working temperature:  
-10°C/+100°C  
With upstream and downstream drain plug

DN		L (mm)	Kg	Ref.
mm	inch			
10	3/8"	63	0,23	CA1102-0010
15	1/2"	68,5	0,24	CA1102-0015
20	3/4"	69,5	0,40	CA1102-0020
25	1"	79	0,46	CA1102-0025
32	1"1/4	84	0,67	CA1102-0032
40	1"1/2	93,5	0,98	CA1102-0040
50	2"	108	1,45	CA1102-0050



**A placer après votre compteur d'eau : empêche le retour de l'eau dans le réseau de distribution (antipollution). Le CA1102 possède 2 bouchons : un en amont servant à contrôler l'étanchéité du clapet et un deuxième bouchon aval servant à contrôler la qualité de l'eau et éventuellement purger l'installation.**  
To be placed after you water meter: prevents water from returning into the distribution network (antipollution). The threaded type antipollution check valve CA1102 has two caps, one upstream for controlling the seal of the check valve and the other downstream for controlling the quality of the water and for purging the installation.

CA6469

Clapet axial anti-retour à ressort entre brides  
Wafer type axial non-return check valve with spring



Corps : Inox A351 CF8M  
Obturbateur : Inox A351 CF8M  
Ressort : Inox 316  
Étanchéité : Métal / métal  
Guide et visserie : Inox 316  
Raccordement :  
Entre brides PN10/16/25/40/ASA150  
Pression de service : 40 bar  
Température de service : -60°C/+300°C  
(conditions d'utilisation voir le passeport technique)

Body: Stainless steel A351 CF8M  
Disc: Stainless steel A351 CF8M  
Spring: Stainless steel 316  
Seal: Metal / metal  
Cover and bolts: Stainless steel 316  
Connection:  
Between flanges PN10/16/25/40/ASA150  
Working pressure: 40 bar  
Working temperature: -60°C/+300°C  
(conditions of use see technical sheet)



**Encombrement réduit, faibles pertes de charge**  
Small face to face, low head losses

DN		L (mm)	Kg	Ref.
mm	inch			
15	1/2"	16	0,11	CA6469-0015
20	3/4"	19	0,20	CA6469-0020
25	1"	22	0,30	CA6469-0025
32	1"1/4	28	0,50	CA6469-0032
40	1"1/2	32	0,60	CA6469-0040
50	2"	40	1	CA6469-0050
65	2" 1/2	46	1,35	CA6469-0065
80	3"	50	2	CA6469-0080
100	4"	60	3,2	CA6469-0100
125	5"	90	7,6	CA6469-0125
150	6"	106	11	CA6469-0150
200	8"	140	19	CA6469-0200
250	10"	145	28	CA6469-0250
300	12"	160	38	CA6469-0300

CA7441

Clapet axial à ressort entre brides  
Wafer type axial type swing check valve

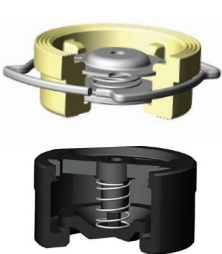

Corps : Laiton DN32-100  
Fonte ductile GGG50 DN125-200  
Disque : Inox DN32-100  
Fonte ductile GGG50 DN125-200  
Guide : Inox DN32-100  
Fonte ductile GGG50 DN125-200  
Ressort : Inox  
Étanchéité : Métal / métal  
Raccordement :  
DN32-150: entre brides PN10/PN16  
DN200: entre brides PN16  
Pression de service max : 16 bar  
Température de service : -10°C/+120°C

Body: Brass DN32-100  
Ductile iron GGG50 DN125-200  
Disc: Stainless steel DN32-100  
Ductile iron GGG50 DN125-200  
Guide: Stainless steel DN32-100  
Ductile iron GGG50 DN125-200  
Spring: Stainless steel  
Seal: Metal / metal  
Connection:  
DN32-150: Between flanges PN10/PN16  
DN200: between flanges PN16  
Maximum working pressure: 16 bar  
Working temperature: -10°C/+120°C

DN		L (mm)	Kg	Ref.
mm	inch			
32	1"1/4	28	0,46	CA7441-0032
40	1"1/2	31,5	0,62	CA7441-0040
50	2"	40	0,98	CA7441-0050
65	2"1/2	46	1,36	CA7441-0065
80	3"	50	2,08	CA7441-0080
100	4"	60	3,03	CA7441-0100
125	5"	90	6,80	CA7441-0125
150	6"	106	10	CA7441-0150
200	8"	140	20	CA7441-0200

## CA6179 BSP | CA6779 NPT | CA6979 BW | CA6379 SW

## Clapet 3 pièces toutes positions

Any position 3 pieces check valve

NEW

BIENTÔT DISPONIBLE - MARS 2021  
COMING SOON - MARCH 2021

CA6979 DN50 - BW



ATEX II 2 GD C T2

Montage toutes positions  
All mounting positions

Corps : Inox A351 CF8M  
Disque : Inox AISI 316  
Ressort : Inox 316  
Étanchéité : Métal / métal  
Raccordement :  
CA6179-MM : Femelle BSP  
CA6779-MM : Femelle NPT  
CA6979-MM : A Souder en Bout BW  
CA6379-MM : A Souder à emboîtement SW  
Pression de service max : 63 bar  
Température de service : -25°C/+180°C

Body: Stainless steel A351 CF8M  
Disc: Stainless steel AISI 316  
Spring: Stainless steel 316  
Seal: Metal / metal  
Connection:  
CA6179-MM: female BSP  
CA6779-MM: female NPT  
CA6979-MM: Butt Welding  
CA6379-MM: Socket Welding  
Maximum working pressure: 63 bar  
Working temperature: -25°C/+180°C

DN		L (mm)	Kg	Ref.
mm	inch			
8	1/4"	49	0,18	CA6179-MM0008 CA6779-MM0008 CA6979-MM0008 CA6379-MM0008
10	3/8"	49	0,18	CA6179-MM0010 CA6779-MM0010 CA6979-MM0010 CA6379-MM0010
15	1/2"	56	0,30	CA6179-MM0015 CA6779-MM0015 CA6979-MM0015 CA6379-MM0015
20	3/4"	65	0,43	CA6179-MM0020 CA6779-MM0020 CA6979-MM0020 CA6379-MM0020
25	1"	74	0,61	CA6179-MM0025 CA6779-MM0025 CA6979-MM0025 CA6379-MM0025
32	1 1/4"	83	1	CA6179-MM0032 CA6779-MM0032 CA6979-MM0032 CA6379-MM0032
40	1 1/2"	91	1,32	CA6179-MM0040 CA6779-MM0040 CA6979-MM0040 CA6379-MM0040
50	2"	110	2,14	CA6179-MM0050 CA6779-MM0050 CA6979-MM0050 CA6379-MM0050
65	2 1/2"	126	4	CA6179-MM0065 CA6779-MM0065 CA6979-MM0065 CA6379-MM0065
80	3"	141	5,71	CA6179-MM0080 CA6779-MM0080 CA6979-MM0080 CA6379-MM0080
100	4"	162	10	CA6179-MM0100 CA6779-MM0100 CA6979-MM0100 CA6379-MM0100

## CA6190

## Clapet à bille toutes positions taraudé

Female BSP all mounting positions ball check valve



Corps : Inox 316  
Bille : Inox 316  
Ressort : Inox 304  
Étanchéité : Métal / métal  
Raccordement : Femelle/Femelle BSP  
Pression de service max : 400 bar  
Température de service : -20°C/+180°C

Body: Stainless steel 316  
Ball: Stainless steel 316  
Spring: Stainless steel 304  
Seal: Metal / metal  
Connection: BSP female  
Maximum working pressure: 400 bar  
Working temperature: -20°C/+180°C

DN		L (mm)	Kg	Ref.
mm	inch			
8	1/4"	90	0,50	CA6190-0008
10	3/8"	90	0,50	CA6190-0010
15	1/2"	90	0,52	CA6190-0015
20	3/4"	130	0,88	CA6190-0020
25	1"	140	1,50	CA6190-0025



CA3241 | CA3201 | CA4208A | CA4248A

Clapet axial à brides PN10/PN16  
Flanged type axial check valve PN10/PN16



**Corps :**  
DN50-300 : Fonte EN-GJL-250 (GG25)  
DN350-600 : Fonte ductile EN-GJS-400-15 (GGG40)  
**Disque :** Fonte ductile EN-GJS-400-15 (GGG40)  
**Guide :** Fonte ductile EN-GJS-400-15 (GGG40)  
**Ressort :**  
DN50-300 : Inox 316  
DN350-600 : Inox 304  
**Étanchéité :** Nitrile  
**Raccordement :** À brides PN10, PN16  
**Pression de service max :** 10 ou 16 bar  
**Température de service max :** +100°C

**Body:**  
DN50-300 : Cast iron EN-GJL-250 (GG25)  
DN350-600 : Ductile iron EN-GJS-400-15 (GGG40)  
**Disc:** Ductile iron EN-GJS-400-15 (GGG40)  
**Guide:** Ductile iron EN-GJS-400-15 (GGG40)  
**Spring:**  
DN50-300: Stainless steel 316  
DN350-600: Stainless steel 304  
**Seal:** Nitrile  
**Connection:** Flanged PN10, PN16  
**Maximum working pressure:** 10 or 16 bar  
**Maximum working temperature:** +100°C

DN				Kg	PN10	PN16
mm	inch	L (mm)	Ref.		Ref.	
50	2"	100	5,09	voir / see PN16		CA3241-0050
65	2" 1/2	120	7,85		CA3241-0065	
80	3"	140	9,53		CA3241-0080	
100	4"	170	13,2		CA3241-0100	
125	5"	200	20,5		CA3241-0125	
150	6"	230	29,6		CA3241-0150	
200	8"	300	47,3	CA3201-0200	CA3241-0200	
250	10"	370	68	CA3201-0250	CA3241-0250	
300	12"	410	112	CA3201-0300	CA3241-0300	
350	14"	425	180	CA4208A-0350	CA4248A-0350	
400	16"	475	240	CA4208A-0400	CA4248A-0400	
450	18"	-	-	CA4208A-0450	CA4248A-0450	
500	20"	587	380	CA4208A-0500	CA4248A-0500	
600	24"	710	590	CA4208A-0600	CA4248A-0600	

CLAPET / FLITE  
CHECK VALVE / STRAINER

PRODUIT ASSOCIÉ | RELATED PRODUCT

Crépine pour clapet axial à brides PN10 ou PN16  
Strainer for flanged type axial check valve PN10 or PN16

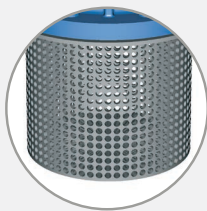

**Raccordement :** Montage sur bride  
**Connection:** Flange mounting

			Acier galvanisé / Galvanized steel	
DN			PN10	PN16
mm	inch		Ref.	Ref.
50	2"	voir / see PN16		CA3241CREPINE-0050
65	2" 1/2			CA3241CREPINE-0065
80	3"			CA3241CREPINE-0080
100	4"			CA3241CREPINE-0100
125	5"			CA3241CREPINE-0125
150	6"		CA3241CREPINE-0150	
200	8"	CR5200-0200	CA3241CREPINE-0200	CA3241CREPINE-0200
250	10"	CR5200-0250	CA3241CREPINE-0250	CA3241CREPINE-0250
300	12"	CR5200-0300	CA3241CREPINE-0300	CA3241CREPINE-0300
350	14"	CR5200-0350	CR5240-0350	CR5240-0350
400	16"	CR5200-0400	CR5240-0400	CR5240-0400
450	18"	CR5200-0450	CR5240-0450	CR5240-0450
500	20"	CR5200-0500	CR5240-0500	CR5240-0500
600	24"	CR5200-0600	CR5240-0600	CR5240-0600

			Inox 304 / Stainless steel 304	
DN			PN10	PN16
mm	inch		Ref.	Ref.
50	2"	voir / see PN16		CA3241CREPINOX-0050
65	2" 1/2			CA3241CREPINOX-0065
80	3"			CA3241CREPINOX-0080
100	4"			CA3241CREPINOX-0100
125	5"			CA3241CREPINOX-0125
150	6"			CA3241CREPINOX-0150
200	8"			CA3241CREPINOX-0200
250	10"			CA3241CREPINOX-0250
300	12"			CA3241CREPINOX-0300
350	14"		CR6200-0350	CR6240-0350
400	16"	CR6200-0400	CR6240-0400	CR6240-0400
450	18"	CR6200-0450	CR6240-0450	CR6240-0450
500	20"	CR6200-0500	CR6240-0500	CR6240-0500
600	24"	CR6200-0600	CR6240-0600	CR6240-0600

			Inox 316L / Stainless steel 316L		
DN			PN10	PN16	
mm	inch		Ref.	Ref.	
50	2"	voir / see PN16		CR6249-0050	
65	2" 1/2			CR6249-0065	
80	3"			CR6249-0080	
100	4"			CR6249-0100	
125	5"			CR6249-0125	
150	6"			CR6249-0150	
200	8"		CR6209-0200	CR6249-0200	CR6249-0200
250	10"		CR6209-0250	CR6249-0250	CR6249-0250
300	12"		CR6209-0300	CR6249-0300	CR6249-0300
350	14"		CR6209-0350	CR6249-0350	CR6249-0350
400	16"	CR6209-0400	CR6249-0400	CR6249-0400	
450	18"	CR6209-0450	CR6249-0450	CR6249-0450	
500	20"	CR6209-0500	CR6249-0500	CR6249-0500	
600	24"	CR6209-0600	CR6249-0600	CR6249-0600	



CA3242

Clapet toutes positions à brides

All mounting position flanged check valve



**Corps :** Fonte EN-GJL-250 Epoxy (GG25) ACS  
**Disque :** Fonte ductile EN-GJS-400-15 (GG40)  
**Ressort :** Inox 302  
**Etanchéité :** EPDM ACS  
**Raccordement :** A brides PN16 jusqu'au DN300 - PN10 au delà  
**Pression de service max :** 16 bar  
**Température de service :** -10°C / +120°C

**Body :** Cast iron EN-GJL-250 (GG25) Epoxy coated ACS  
**Disc :** Ductile iron EN-GJS-400-15 (GG40)  
**Spring :** Stainless steel 302  
**Seal :** ACS EPDM  
**Connection :** Flanged PN16 up through DN300, PN10 for all above  
**Maximum working pressure :** 16 bar  
**Working temperature :** -10°C / +120°C

DN		L (mm)	PN	Kg	Ref.
mm	inch				
50	2"	100	16	5,42	CA3242-0050
65	2" 1/2	120	16	8,22	CA3242-0065
80	3"	140	16	10,13	CA3242-0080
100	4"	165	16	13,53	CA3242-0100
125	5"	195	16	19,5	CA3242-0125
150	6"	230	16	27,07	CA3242-0150
200	8"	290	16	46,8	CA3242-0200
250	10"	355	16	77,2	CA3242-0250
300	12"	400	16	128	CA3242-0300
350	14"	480	10	260	CA3242-0350
400	16"	550	10	260	CA3242-0400
500	20"	680	10	500	CA3242-0500
600	24"	800	10	780	CA3242-0600



CA4251 | CA4261

Clapet axial à brides haute pression

High pressure axial type check valve



**Corps :** Fonte EN-GJS-400-15 (GGG40)  
**Clapet :** Fonte EN-GJS-400-15 (GGG40)  
**Ressort :** Inox 304  
**Etanchéité :** NBR  
**Raccordement :** A brides PN25 ou PN40  
**Pression de service max :** 25 bar - 40 bar  
**Température de service max :** -10°C / +80°C

**Body :** Ductile iron EN-GJS-400-15 (GGG40)  
**Disc :** Ductile iron EN-GJS-400-15 (GGG40)  
**Spring :** Stainless steel 304  
**Seal :** NBR  
**Connection :** Flanged PN25 or PN40  
**Maximum working pressure :** 25 bar - 40 Bar  
**Maximum working temperature :** -10°C / +80°C

DN			PN25		PN40	
mm	inch	L (mm)	Ref.	Kg	Ref.	Kg
50	2"	125	CA4251-0050	6	CA4261-0050	7
65	2" 1/2	145	CA4251-0065	8	CA4261-0065	9
80	3"	155	CA4251-0080	12	CA4261-0080	13
100	4"	175	CA4251-0100	17	CA4261-0100	19
125	5"	200	CA4251-0125	23	CA4261-0125	25
150	6"	225	CA4251-0150	35	CA4261-0150	39
200	8"	275	CA4251-0200	60	CA4261-0200	66
250	10"	325	CA4251-0250	95	CA4261-0250	105
300	12"	375	CA4251-0300	130	CA4261-0300	143
350	14"	425	CA4251-0350	180	CA4261-0350	198
400	16"	475	CA4251-0400	240	CA4261-0400	264
450	18"	500	CA4251-0450	264	CA4261-0450	-
500	20"	587	CA4251-0500	380	CA4261-0500	418
600	24"	710	CA4251-0600	590	CA4261-0600	650

**Haute pression**  
**High pressure**

CEA5245 | CEA5205

Clapet d'entrée d'air acier carbone

Carbon steel air inlet check valve



**Corps :** Acier carbone ST37  
**Tige :** Inox 304  
**Palier de guidage :** Bronze  
**Siège :** NBR  
**Raccordement :** A brides PN10/16 suivant EN1092-1  
**Pression de service :** 10/16 bar (voir tableau)  
**Body :** Carbon Steel ST37 Epoxy coated  
**Stem :** Inox 304  
**Bearing :** Bronze  
**Seat :** NBR  
**Connection :** Flanged PN10/16  
**Working pressure :** 10/16 bar (see chart)



DN		L (mm)	Kg	PN	Ref.
mm	inch				
50	2"	280	17	10/16	CEA5245-0050
80	3"	300	25	10/16	CEA5245-0080
100	4"	340	33	10/16	CEA5245-0100
150	6"	400	45	10/16	CEA5245-0150
200	8"	470	66	10	CEA5205-0200
			70	16	CEA5245-0200
250	10"	500	90	10	CEA5205-0250
			95	16	CEA5245-0250
300	12"	520	105	10	CEA5205-0300
			110	16	CEA5245-0300

**A monter sur col de cygne**  
**To mount on a goose neck**

**Permet l'entrée d'air à grand débit dans la conduite afin d'éviter une dépression en phase de vidange.**  
**Allows a high-flow air intake into the pipe to prevent a vacuum from forming in the emptying phase.**



**CLAPETS À BOULE  
BALL CHECK VALVES**

**CBL4141**

Clapet à boule femelle BSP  
Female BSP ball check valve



Corps : Fonte Ductile EN-GJS-500-7 (GGG50)  
Boule :  
DN 25-50 : Nitrile  
DN 65 : Aluminium + Nitrile  
Joint : Nitrile  
Raccordement : Femelle BSP  
Pression de service : 10 bar  
Température de service : -10°C/+90°C

Body: Ductile Iron EN-GJS-500-7 (GGG50)  
Ball:  
DN 25-50: NBR  
DN 65: Aluminium + NBR  
O-ring: NBR  
Connection: Female BSP  
Working pressure: 10 bar  
Working temperature: -10°C/+90°C

DN		L (mm)	Kg	Ref.
mm	inch			
25	1" *	125	1,3	CBL4141-0025 *
32	1"1/4	133	1,5	CBL4141-0032
40	1"1/2	151	2,1	CBL4141-0040
50	2"	175	3,2	CBL4141-0050
65	2"1/2	202	4,3	CBL4141-0065

\* non CE / not CE

**CBL4240**

Clapet à boule à brides  
Flanged type ball check valve



Corps : Fonte Ductile EN-GJS-500-7 (GGG50)  
Boule :  
DN40-50 : Nitrile  
DN65-80 : Aluminium + Nitrile  
DN100-400 : Fonte + Nitrile  
Raccordement : A brides PN10  
Pression de service : 10 bar  
Température de service : -10°C/+80°C

Body: Ductile Iron EN-GJS-500-7 (GGG50)  
Ball:  
DN40-50: NBR  
DN65-80: Aluminium + NBR  
DN100-400: Cast Iron + NBR  
Connection: Flanged PN10  
Working pressure: 10 bar  
Working temperature: -10°C/+80°C

DN		L (mm)	Kg	Ref.	DN		L (mm)	Kg	Ref.
mm	inch				mm	inch			
40	1" 1/2	180	5,6	CBL4240-0040	250	10"	600	125,3	CBL4240-0250
50	2"	200	7,5	CBL4240-0050	300	12"	700	177	CBL4240-0300
65	2" 1/2	240	10,1	CBL4240-0065	350	14"	800	276	CBL4240-0350
80	3"	260	12,8	CBL4240-0080	400	16"	900	423	CBL4240-0400
100	4"	300	18,4	CBL4240-0100	450*	18"	1000	500	CBL4240-0450
125	5"	350	30,2	CBL4240-0125	500*	20"	1100	680	CBL4240-0500
150	6"	400	38,5	CBL4240-0150	600 *	24"	1300	1095	CBL4240-0600
200	8"	500	76	CBL4240-0200					

\* non CE / not CE



**Anneau de levage sur le chapeau (jusqu'au DN400) équilibrant le clapet pour une manutention aisée lors de la pose de la conduite. Montage horizontal ou vertical avec fluide ascendant. Lifting hook on the bonnet (up to the DN400) for easy handling. Can be mounted horizontally or vertically but with flow going down to up.**

**PRODUITS ASSOCIÉS | RELATED PRODUCTS**

**CBL4240JOINT**

Joint de chapeau pour clapet CBL4240  
Bonnet gasket for CBL4240 ball check valve



Matière : NBR  
Material: NBR

DN		Ref.	DN		Ref.
mm	inch		mm	inch	
40	1" 1/2	CBL4240JOINT-0040	150	6"	CBL4240JOINT-0150
50	2"	CBL4240JOINT-0050	200	8"	CBL4240JOINT-0200
65	2" 1/2	CBL4240JOINT-0065	250	10"	CBL4240JOINT-0250
80	3"	CBL4240JOINT-0080	300	12"	CBL4240JOINT-0300
100	4"	CBL4240JOINT-0100	350	14"	CBL4240JOINT-0350
125	5"	CBL4240JOINT-0125	400	16"	CBL4240JOINT-0400

DN450 au 600 sur demande / DN450 up to 600 on request

**CBL4240BOU**

Boule nitrile pour clapet CBL4240  
Nitrile ball for CBL4240 ball check valve



Boule autonettoyante revêtue nitrile  
Nitrile-coated self-cleaning steel ball

DN		Ref.	DN		Ref.
mm	inch		mm	inch	
40	1" 1/2	CBL4240BOU-NI0040	150	6"	CBL4240BOU-NI0150
50	2"	CBL4240BOU-NI0050	200	8"	CBL4240BOU-NI0200
65	2" 1/2	CBL4240BOU-NI0065	250	10"	CBL4240BOU-NI0250
80	3"	CBL4240BOU-NI0080	300	12"	CBL4240BOU-NI0300
100	4"	CBL4240BOU-NI0100	350	14"	CBL4240BOU-NI0350
125	5"	CBL4240BOU-NI0125	400	16"	CBL4240BOU-NI0400

DN450 au 600 sur demande / DN450 up to 600 on request

## CBL4230

ASA 150

## Clapet à boule à brides en fonte ductile - ASA150

Flanged Ductile iron ball check valve - ASA150



**Corps et chapeau :**  
Fonte ductile EN-GJS-500-7 (GGG50)  
**Boule :** Fonte revêtue Nitrile  
**Joint de chapeau :** Nitrile  
**Raccordement :** À brides ASA150  
**Pression de service :** 10 bar  
**Température de service :** -10°C/+80°C

NEW

**Body and cover:** Ductile iron EN-GJS-500-7 (GGG50)  
**Ball:** NBR  
**O-ring:** NBR  
**Connection:** Flanged ASA150  
**Working pressure:** 10 bar  
**Working temperature:** -10°C/+80°C

DN		L (mm)	Kg	Ref.
mm	inch			
40	1" 1/2	180	5,6	CBL4230-0040
50	2"	200	7,5	CBL4230-0050
65	2" 1/2	240	10,1	CBL4230-0065
80	3"	260	12,8	CBL4230-0080
100	4"	300	18,4	CBL4230-0100
125	5"	350	30,2	CBL4230-0125
150	6"	400	38,5	CBL4230-0150
200	8"	500	76	CBL4230-0200
250	10"	600	125,3	CBL4230-0250



**Anneau de levage sur le chapeau équilibrant le clapet pour une manutention aisée lors de la pose de la conduite.**

**Montage horizontal ou vertical avec fluide ascendant.**

**Lifting hook on the bonnet for easy handling.**

**Can be mounted horizontally or vertically but with flow going down to up.**

## CBL420G

Application abrasive | Abrasive application

## Clapet à boule application abrasive - PN10

Flanged Ductile iron ball check valve for abrasive application - PN10



**Corps et chapeau :**  
Fonte ductile EN-GJS400-15 revêtue de gomme naturelle anti-abrasive  
**Boule :** Polyuréthane  
**Boulonnerie :** Acier inoxydable A2  
**Raccordement :** À brides PN10  
**Pression de service max :** 10 bar  
**Température de service :** -10°C/+80°C

NEW

**Body and cover:** Ductile iron EN-GJS400-15 with anti-abrasive rubber lining  
**Ball:** Polyurethane  
**Bolts:** Stainless steel A2  
**Connection:** Flanged PN10  
**Maximum working pressure:** 10 bar  
**Working temperature:** -10°C/+80°C

DN		L (mm)	Kg	Ref.
mm	inch			
100	4"	300	21,5	CBL420G-0100
125	5"	350	36	CBL420G-0125
150	6"	400	45	CBL420G-0150
200	8"	500	80	CBL420G-0200
250	10"	600	120	CBL420G-0250
300	12"	700	180	CBL420G-0300
350	14"	800	270	CBL420G-0350
400	16"	900	440	CBL420G-0400
500	20"	1100	680	CBL420G-0500



**Application abrasive**  
**Abrasive application**

## CBL6149

## Clapet à boule femelle BSP

Female BSP ball check valve



**Corps :** Inox 316 embouti  
**Boule :** Aluminium revêtu FPM  
**Joint :** FPM  
**Raccordement :** Femelle BSP  
**Pression de service :** 16 bar  
**Température de service :** +150°C

**Body:** Stamped Stainless steel 316  
**Ball:** Aluminium FPM coated  
**O-ring:** FPM  
**Connection:** Female BSP  
**Working pressure:** 16 bar  
**Working temperature:** +150°C

DN		L (mm)	Kg	Ref.
mm	inch			
32	1" 1/4	175	1,1	CBL6149-0032
40	1" 1/2	190	1,18	CBL6149-0040
50	2"	210	1,61	CBL6149-0050

## CBL6240

## Clapet à boule à brides Inox

Stainless steel female BSP ball check valve



**Corps :**  
DN 50-200 : Inox 316  
DN 250-400 : Inox 316  
**Boule :** Aluminium + Nitrile  
**Joint :** Nitrile  
**Raccordement :** À brides PN10 ou PN16  
**Pression de service :** 16 bar jusqu'au DN150  
10 bar à partir du DN200  
**Température de service :** -10°C/+80°C

NEW

**Body:**  
DN 50-200: Stainless steel 316  
DN 250-400: Stainless steel 316  
**Ball:** Aluminium + NBR  
**O-ring:** NBR  
**Connection:** Flanged PN10 or PN16  
**Working pressure:** 16 bar until DN150  
10 bar from DN200  
**Working temperature:** -10°C/+80°C

DN		L (mm)	Kg	Ref.
mm	inch			
50	2"	200	8,5	CBL6240-0050
65	2" 1/2	240	12,5	CBL6240-0065
80	3"	260	15,6	CBL6240-0080
100	4"	300	21	CBL6240-0100
125	5"	350	30	CBL6240-0125
150	6"	400	41	CBL6240-0150
200	8"	500	69	CBL6240-0200

CE





## CLAPETS À BATTANT SWING CHECK VALVES

### CB1102

Clapet de retenue à battant laiton femelle BSP  
Female BSP brass swing check valve



Corps : Laiton  
Battant : Laiton  
Axe : Laiton  
Étanchéité :  
Du 3/8" au 2" Metal / EPDM  
Du 2"1/2 au 4" Metal / NBR  
Raccordement : Femelle BSP  
Pression de service max : 10 bar  
Température de service : 0°C/+60°C

Body: Brass  
Disc: Brass  
Stem: Brass  
Seal:  
3/8" to 2" Metal/EPDM  
2"1/2 to 4" Metal/NBR  
Connection: Female BSP  
Maximum working pressure: 10 bar  
Working temperature: 0°C/+60°C

DN		L (mm)	Kg	Ref.
mm	inch			
10	3/8"	47	0,182	CB1102-0010
15	1/2"	47	0,158	CB1102-0015
20	3/4"	53	0,231	CB1102-0020
25	1"	63	0,370	CB1102-0025
32	1"1/4	74	0,554	CB1102-0032
40	1"1/2	87	0,726	CB1102-0040
50	2"	97	1,268	CB1102-0050
65	2"1/2	116	1,579	CB1102-0065
80	3"	135	2,253	CB1102-0080
100	4"	164	3,837	CB1102-0100

### CB2143

Clapet de retenue à battant bronze femelle BSP  
Female BSP bronze swing check valve



Corps : Bronze  
Battant : Bronze  
Étanchéité : Nitrile  
Raccordement : Femelle BSP  
Pression de service : 20 bar  
Température de service max : +80°C

Body: Bronze  
Disc: Bronze  
Seal: Nitrile  
Connection: Female BSP  
Working pressure: 20 bar  
Maximum Working temperature: +80°C

**JUSQU'À ÉPUISEMENT DES STOCKS  
WHILE STOCKS LAST**

DN		L (mm)	Kg	Ref.
mm	inch			
15	1/2"	49	0,16	CB2143-0015
20	3/4"	58	0,23	CB2143-0020
25	1"	68	0,27	CB2143-0025
32	1"1/4	76	0,55	CB2143-0032
50	2"	103	1,13	CB2143-0050

### CB2143W

Clapet de retenue à battant bronze femelle BSP - WRAS  
Female BSP bronze swing check valve - WRAS



Corps : Bronze  
Clapet : Nitrile  
Raccordement : Femelle BSP  
Pression de service : 20 bar  
Température de service max :  
-10°C / + 100°C

Body: Bronze  
Disc: NBR  
Connection: Female BSP  
Working pressure: 20 bar  
Maximum Working temperature:  
-10°C / + 100°C

**BIENTÔT DISPONIBLE  
COMING SOON**



DN		L (mm)	Kg	Ref.
mm	inch			
15	1/2"	58	0,25	CB2143W-0015
20	3/4"	66	0,38	CB2143W-0020
25	1"	76	0,60	CB2143W-0025
32	1"1/4	88	0,87	CB2143W-0032
40	1"1/2	96	1,15	CB2143W-0040
50	2"	112	1,79	CB2143W-0050

### CB6140

Clapet de retenue à battant Inox femelle BSP  
Female BSP Stainless steel swing check valve



Corps : ASTM A351 CF8M  
Battant : ASTM A182 F304  
Axe : ASTM A182 F304  
Étanchéité : Métal/métal  
Raccordement : Femelle BSP  
Pression de service max : 16 bar  
Température de service : -20°C/+200°C

Body: ASTM A351 CF8M  
Disc: ASTM A182 F304  
Stem: ASTM A182 F304  
Seal: Metal/metal  
Connection: female BSP  
Maximum working pressure: 16 bar  
Working temperature: -20°C/+200°C

DN		L (mm)	Kg	Ref.
mm	inch			
8	1/4"	65	0,264	CB6140-0008
10	3/8"	65	0,280	CB6140-0010
15	1/2"	65	0,320	CB6140-0015
20	3/4"	80	0,530	CB6140-0020
25	1"	90	0,750	CB6140-0025
32	1"1/4	103	1,030	CB6140-0032
40	1"1/2	120	1,590	CB6140-0040
50	2"	141	2,310	CB6140-0050

## CB3240PN10 | CB3240PN16

## Etanchéité M/M | M/M seal

Clapet à battant à brides  
Flanged type swing check valve



Corps : Fonte EN-GJL-250 (GG25)  
Battant : Fonte EN-GJL-250 (GG25)  
Etanchéité : Laiton / laiton  
Raccordement : À brides PN10 et PN16  
Pression de service : 10 bar - 16 bar  
Température de service max : +150°C

Body: Cast iron EN-GJL-250 (GG25)  
Disc: Cast iron EN-GJL-250 (GG25)  
Seal: Brass / brass  
Connection: Flanged PN10 and PN16  
Working pressure: 10 bar - 16 bar  
Maximum Working temperature: +150°C

DN		L (mm)	Kg	Ref.
mm	inch			
40	1"1/2	180	9	CB3240PN16-0040
50	2"	200	12	CB3240PN16-0050
65	2"1/2	240	16	CB3240PN16-0065
80	3"	260	20	CB3240PN16-0080
100	4"	300	27	CB3240PN16-0100
125	5"	350	42	CB3240PN16-0125
150	6"	400	58	CB3240PN16-0150
200	8"	500	93	CB3240PN10-0200 CB3240PN16-0200
250	10"	600	155	CB3240PN10-0250 CB3240PN16-0250
300	12"	700	221	CB3240PN10-0300 CB3240PN16-0300
350	14"	800	306	CB3240PN10-0350 Ⓞ CB3240PN16-0350
400	16"	900	430	CB3240PN10-0400 Ⓞ CB3240PN16-0400

## CB3241PN10 | CB3241PN16

## Etanchéité EPDM | EPDM seal

Clapet à battant à brides  
Flanged type swing check valve



Corps : Fonte EN-GJL -250 (GG25)  
Battants : Fonte EN-GJL -250 (GG25)  
Etanchéité : EPDM  
Raccordement : A brides PN16  
Pression de service max : 16 bar  
Température de service max : -10°C/80°C

Body: Cast iron EN-GJL -250 (GG25)  
Disc: Cast iron EN-GJL -250 (GG25)  
Seal: EPDM  
Connection: Flanged PN16  
Maximum working pressure: 16 bar  
Maximum working temperature: -10°C/80°C

DN		L (mm)	Kg	Ref.
mm	inch			
40	1"1/2	180	9	CB3241PN16-0040
50	2"	200	12	CB3241PN16-0050
65	2"1/2	240	16	CB3241PN16-0065
80	3"	260	20	CB3241PN16-0080
100	4"	300	27	CB3241PN16-0100
125	5"	350	42	CB3241PN16-0125
150	6"	400	58	CB3241PN16-0150
200	8"	500	93	CB3241PN16-0200 CB3241PN10-0200
250	10"	600	155	CB3241PN16-0250 CB3241PN10-0250 Ⓞ
300	12"	700	221	CB3241PN16-0300 CB3241PN10-0300 Ⓞ
350	14"	800	306	CB3241PN16-0350 CB3241PN10-0350 Ⓞ
400	16"	900	430	CB3241PN16-0400 CB3241PN10-0400 Ⓞ

## CB4251

## Haute pression | High pressure

Clapet à battant à brides PN25  
Flanged PN25 swing check valve



Corps & chapeau : Fonte EN-GJS-400-15 (GGG40)  
Siège : Alliage cuivreux  
Axe de manoeuvre : Acier Inoxydable 420  
Visserie : Acier galvanisé CLASSE 8.8  
Raccordement : A brides PN25  
Température de service : -10°C / +80°C

Body & Cover: Ductile Iron EN-GJS-400-15 (GGG40)  
Seat: Copper alloy  
Shaft: Stainless steel 420  
Bolts and nuts: Carbon steel galvanized 8.8  
Connection: Flanged PN25  
Working temperature: -10°C / +80°C

	DN		L (mm)	Kg	Ref.	
	mm	inch				
Battant Acier carbone revêtu EPDM	40	1" 1/2	180	10	CB4251-0040	
	50	2"	200	13	CB4251-0050	
	65	2" 1/2	240	21	CB4251-0065	
	80	3"	260	22	CB4251-0080	
	100	4"	300	25	CB4251-0100	
	125	5"	350	40	CB4251-0125	
	Disc Carbon steel with EPDM coating	150	6"	400	52	CB4251-0150
		200	8"	450	149	CB4251-0200
250		10"	600	182	CB4251-0250	
300		12"	700	316	CB4251-0300	
350		14"	800	432	CB4251-0350	
400		16"	900	550	CB4251-0400	
Battant Disc GGG40		450	18"	1000	670	CB4251-0450
		500	20"	1100	880	CB4251-0500
	600	24"	1300	1102	CB4251-0600	
	700	28"	1500	1800	CB4251-0700	
	800	32"	1700	2250	CB4251-0800	



CB4261

Haute pression | High pressure

Clapet à battant à brides PN40  
Flanged PN40 swing check valve



Corps & chapeau : Fonte EN-GJS-400-15 (GGG40)  
Siège : Alliage cuivreux  
Axe de manoeuvre : Acier Inoxydable 420  
Visserie : Acier galvanisé CLASSE 8.8  
Raccordement : A brides PN40  
Température de service : -10°C / +80°C

Body & Cover: Ductile Iron EN-GJS-400-15 (GGG40)  
Seat: Copper alloy  
Shaft: Stainless steel 420  
Bolts and nuts: Carbon steel galvanized 8.8  
Connection: Flanged PN40  
Working temperature: -10°C / +80°C

	DN		L (mm)	Kg	Ref.
	mm	inch			
Battant Acier carbone revêtu EPDM	40	1" 1/2	180	11	CB4261-0040
	50	2"	200	14	CB4261-0050
	65	2" 1/2	240	23	CB4261-0065
	80	3"	260	24	CB4261-0080
	100	4"	300	28	CB4261-0100
	125	5"	350	43	CB4261-0125
Disc Carbon steel with EPDM coating	150	6"	400	56	CB4261-0150
	200	8"	450	162	CB4261-0200
	250	10"	600	198	CB4261-0250
	300	12"	700	344	CB4261-0300
Battant Disc GGG40	350	14"	800	472	CB4261-0350
	400	16"	900	600	CB4261-0400
	450	18"	1000	755	CB4261-0450
	500	20"	1100	960	CB4261-0500
	600	24"	1300	1200	CB4261-0600
	700	28"	1500	1800	CB4261-0700
800	32"	1700	2250	CB4261-0800	

CLAPET/FILTRE  
CHECK VALVE/ STRAINER

CB4205 | 08 | 45 | 48 | 55 | 58 | 65 | 68

Clapet à battant à contrepoids | Swing check valve with counterweight

Clapet à battant à brides à contrepoids  
Flanged type swing check valve with counterweight



Corps & chapeau : Fonte ductile EN-GJS-400-15 (GGG40)  
Siège : Alliage cuivreux  
Axe de manoeuvre : Acier Inoxydable 420  
Visserie : Acier galvanisé CLASSE 8.8  
Lever : Acier carbone  
Contrepoids : Fonte ductile EN-GJS-400-15 (GGG40)  
Raccordement : A brides (PN voir tableaux)  
Température de service : -10°C / +80°C

Body & Cover: Ductile Iron EN-GJS-400-15 (GGG40)  
Seat: Copper alloy  
Shaft: Stainless steel 420  
Bolts and nuts: Carbon steel galvanized 8.8  
Lever: Carbon steel  
Counterweight: Fonte EN-GJS-400-15 (GGG40)  
Connection: Flanged (PN see charts)  
Working temperature: -10°C / +80°C

	DN		L (mm)	Kg	PN10	PN16	
	mm	inch			Ref.	Ref.	
Battant Acier carbone revêtu EPDM	40	1" 1/2	180	10	voir / see PN16	CB4245-0040	
	50	2"	200	15		CB4245-0050	
	65	2" 1/2	240	20		CB4245-0065	
	80	3"	260	21		CB4245-0080	
	100	4"	300	33		CB4245-0100	
	125	5"	350	55		CB4245-0125	
	150	6"	400	75		CB4245-0150	
	200	8"	500	126		CB4205-0200	CB4245-0200
	250	10"	600	160		CB4205-0250	CB4245-0250
	300	12"	700	240		CB4205-0300	CB4245-0300
Disc Carbon steel with EPDM coating	350	14"	800	315	CB4205-0350	CB4245-0350	
	400	16"	900	530	CB4205-0400	CB4245-0400	
	450	18"	1000	650	CB4208-0450	CB4248-0450	
	500	20"	1100	830	CB4208-0500	CB4248-0500	
Battant Disc GGG40	600	24"	1300	1050	CB4208-0600	CB4248-0600	
	700	28"	1500	1600	CB4208-0700	CB4248-0700	
	800	32"	1700	2150	CB4208-0800	CB4248-0800	
	1000	40"	2100	3680	CB4208-1000	CB4248-1000	

	DN		L (mm)	PN25		PN40	
	mm	inch		Ref.	Kg	Ref.	Kg
Battant Acier carbone revêtu EPDM	40	1" 1/2	180	CB4255-0040	12	CB4265-0040	16
	50	2"	200	CB4255-0050	17	CB4265-0050	22
	65	2" 1/2	240	CB4255-0065	22	CB4265-0065	30
	80	3"	260	CB4255-0080	25	CB4265-0080	33
	100	4"	300	CB4255-0100	35	CB4265-0100	40
	125	5"	350	CB4255-0125	58	CB4265-0125	63
	150	6"	400	CB4255-0150	78	CB4265-0150	85
	200	8"	500	CB4255-0200	149	CB4265-0200	176
	250	10"	600	CB4255-0250	170	CB4265-0250	200
	300	12"	700	CB4255-0300	390	CB4265-0300	396
Disc Carbon steel with EPDM coated	350	14"	800	CB4255-0350	435	CB4265-0350	475
	400	16"	900	CB4255-0400	650	CB4265-0400	656
	450	18"	1000	CB4258-0450	680	CB4268-0450	760
	500	20"	1100	CB4258-0500	890	CB4268-0500	966
Battant Disc GGG40	600	24"	1300	CB4258-0600	1150	CB4268-0600	1250
	700	28"	1500	CB4258-0700	1680	CB4268-0700	-
	800	32"	1700	CB4258-0800	2300	CB4268-0800	-
	1000	40"	2100	CB4258-1000	3150	CB4268-1000	-



Contactez-nous pour toute demande de **position verticale**; nous préciser la position du clapet lors de votre demande (position livrée en horizontal en standard) ainsi que l'environnement amont/aval du clapet pour vous préconiser l'équipement le plus adapté.

Contact us for any vertical position requests: please specify the position of the check valve (position delivered horizontally as standard) as well as the upstream / downstream environment of the valve to recommend the most suitable equipment.



## CLAPETS SANDWICH SWING CHECK VALVES

### CB5440

#### Acier | Steel

Clapet sandwich entre brides acier  
Steel wafer type swing check valve



Corps et battant : Acier zingué  
Etanchéité : EPDM  
Raccordement :  
Entre-brides PN10/16 jusqu'au DN150  
Entre-brides PN16 à partir du DN200  
Pression de service : 16 bar jusqu'au DN150  
10 bar du DN200 au DN300  
Température de service max : +110°C

Body and Disc: Steel

Seal: EPDM

Connection:

Between flanges PN10/16 up to DN150

Between flanges PN16 from DN200

Working pressure: 16 bar DN40 to DN150

10 bar DN200 to DN300

Maximum Working temperature: +110°C

DN		L (mm)	Kg	Ref.
mm	inch			
40	1" 1/2	16	0,74	CB5440-0040
50	2"	16	0,97	CB5440-0050
65	2" 1/2	16	1,34	CB5440-0065
80	3"	16	1,6	CB5440-0080
100	4"	16	1,99	CB5440-0100
125	5"	16	2,77	CB5440-0125
150	6"	19	4,06	CB5440-0150
200	8"	22	7,11	CB5440-0200
250	10"	32	14,9	CB5440-0250
300	12"	38	21,8	CB5440-0300
350	14"	38	30,1	CB5440-0350
400	16"	44	42,5	CB5440-0400
450	18"	50	68	CB5440-0450
500	20"	56	93	CB5440-0500
600	24"	62	139	CB5440-0600

### CB6441

#### Inox | Stainless steel

Clapet sandwich entre brides inox  
Stainless steel wafer type swing check valve



Corps et battant : Inox 316  
Etanchéité : FPM  
Raccordement :  
Entre-brides PN10/16 jusqu'au DN150  
Entre-brides PN16 à partir du DN200  
Pression de service : 16 bar  
Température de service max : +170°C

Body and Disc: Stainless Steel 316

Seal: FPM

Connection:

Between flanges PN10/16 up to DN150

Between flanges PN16 from DN200

Working pressure: 16 bar

Maximum Working temperature: +170°C

DN		L (mm)	Kg	Ref.
mm	inch			
40	1" 1/2	16	0,77	CB6441-0040
50	2"	16	1	CB6441-0050
65	2" 1/2	16	1,38	CB6441-0065
80	3"	16	1,65	CB6441-0080
100	4"	16	2,02	CB6441-0100
125	5"	16	2,83	CB6441-0125
150	6"	19	4,10	CB6441-0150
200	8"	22	7,18	CB6441-0200
250	10"	32	15,1	CB6441-0250
300	12"	38	22,3	CB6441-0300
350	14"	38	30,2	CB6441-0350
400	16"	44	43,5	CB6441-0400
450	18"	50	68	CB6441-0450
500	20"	56	93	CB6441-0500
600	24"	62	139	CB6441-0600

CE

### CB6441-EPA

#### ACS

Clapet sandwich entre brides inox  
Stainless steel wafer type swing check valve



Corps et battant : Inox 316  
Etanchéité : EPDM ACS  
Raccordement :  
Entre-brides PN10/16 jusqu'au DN150  
Entre-brides PN16 à partir du DN200  
Pression de service : 16 bar jusqu'au DN150  
10 bar du DN200 au DN300  
Température de service : -10°C/+110°C

Body and Disc: Stainless Steel 316

Seal: EPDM ACS

Connection:

Between flanges PN10/16 up to DN150

Between flanges PN16 from DN200

Working pressure: 16 bar DN40 to DN150

10 bar DN200 to DN300

Maximum Working temperature: -10°C/+110°C

DN		PN	L (mm)	Kg	Ref.
mm	inch				
40	1" 1/2	16	16	0,78	CB6441-EPA0040
50	2"	16	16	0,93	CB6441-EPA0050
65	2" 1/2	16	16	1,39	CB6441-EPA0065
80	3"	16	16	1,67	CB6441-EPA0080
100	4"	16	16	2,03	CB6441-EPA0100
125	5"	16	16	2,90	CB6441-EPA0125
150	6"	16	19	4,39	CB6441-EPA0150
200	8"	10	22	9,04	CB6441-EPA0200
250	10"	10	32	15,45	CB6441-EPA0250
300	12"	10	38	23,95	CB6441-EPA0300

CE ACS





## CLAPETS À DOUBLE BATTANT DUAL PLATE CHECK VALVES

### CB3448N-EP

#### Battant fonte ductile | Ductile iron plate

Clapet double battant PN16 - battant fonte ductile

Dual plate check valve PN16 - Ductile iron plate



CE



Corps : Fonte GG25  
Battant : Fonte ductile chromé  
Axe : Inox 410  
Ressorts : Inox 304  
Etanchéité : EPDM  
Pression de service : 16 bar  
Raccordement : Entre-brides  
DN40-600 : PN10/16  
DN700-800 : PN16  
Température de service max : +110°C

Body: Cast Iron GG25  
Plate: Ductile iron chromed  
Shaft: Stainless steel 410  
Springs: Stainless steel 304  
Seal: EPDM  
Working pressure: 16 bar  
Connection: Between flanges  
DN40-600: PN10/16  
DN700-800: PN16  
Maximum Working temperature: +110°C

DN		L (mm)	Kg	Ref.
mm	inch			
40	1" 1/2	43	1	CB3448N-EP0040
50	2"	43	1,3	CB3448N-EP0050
65	2" 1/2	46	1,8	CB3448N-EP0065
80	3"	64	3	CB3448N-EP0080
100	4"	64	3,9	CB3448N-EP0100
125	5"	70	5,7	CB3448N-EP0125
150	6"	76	8	CB3448N-EP0150
200	8"	89	14,3	CB3448N-EP0200
250	10"	114	24,9	CB3448N-EP0250
300	12"	114	33,5	CB3448N-EP0300
350	14"	127	55	CB3448N-EP0350
400	16"	140	75	CB3448N-EP0400
450	18"	152	101	CB3448N-EP0450
500	20"	152	111	CB3448N-EP0500
600	24"	178	172	CB3448N-EP0600
700	20"	229	291	CB3448N-EP0700
800	24"	241	390	CB3448N-EP0800

### CB3449-EPA

#### ACS

Clapet double battant ACS

ACS dual plate check valve



ACS



Corps : Fonte GG25  
Battant : Inox 316  
Axe : Inox 410  
Ressorts : Inox 304  
Etanchéité : EPDM ACS  
Raccordement : Entre-Brides PN10/16  
Pression de service : 16 bar  
Température de service max : +110°C

Body: Cast Iron GG25  
Plate: Stainless Steel 316  
Shaft: Stainless steel 410  
Springs: Stainless steel 304  
Seal: EPDM ACS  
Connection: Between flanges PN10/16  
Working pressure: 16 bar  
Maximum Working temperature: +110°C

DN		L (mm)	Kg	Ref.
mm	inch			
40	1" 1/2	43	1	CB3449-EPA0040
50	2"	43	1,6	CB3449-EPA0050
65	2" 1/2	46	2,4	CB3449-EPA0065
80	3"	64	3,7	CB3449-EPA0080
100	4"	64	4,8	CB3449-EPA0100
125	5"	70	6,7	CB3449-EPA0125
150	6"	76	9	CB3449-EPA0150
200	8"	89	15,6	CB3449-EPA0200
250	10"	114	26,9	CB3449-EPA0250
300	12"	114	36,8	CB3449-EPA0300
350	14"	127	55	CB3449-EPA0350
400	16"	140	73	CB3449-EPA0400
450	18"	152	99	CB3449-EPA0450
500	20"	152	117	CB3449-EPA0500
600	24"	178	177	CB3449-EPA0600



## CB4450

## PN25

## Clapet double battant PN25 - battant fonte ductile

Dual plate check valve PN25 - ductile iron plate



Corps : Fonte Ductile GGG40  
 Battant : GGG40 chromé  
 Axe : Inox 416  
 Ressorts : Inox 304  
 Etanchéité : EPDM  
 Raccordement : Entre-Brides PN25  
 Pression de service : 25 bar  
 Température de service max : +110°C

Body: Ductile Iron GGG40  
 Plate: GGG40 chromed  
 Shaft: Stainless steel 416  
 Springs: Stainless steel 304  
 Seal: EPDM  
 Connection: Between flanges PN25  
 Working pressure: 25 bar  
 Maximum working temperature: +110°C

DN		L (mm)	Kg	Ref.
mm	inch			
40	1" 1/2	43	1,9	CB4450-0040
50	2"	43	2,2	CB4450-0050
65	2" 1/2	46	3,3	CB4450-0065
80	3"	64	4,3	CB4450-0080
100	4"	64	6,6	CB4450-0100
125	5"	70	10,9	CB4450-0125
150	6"	76	12,9	CB4450-0150
200	8"	89	20,1	CB4450-0200
250	10"	114	31,4	CB4450-0250
300	12"	114	50	CB4450-0300
350	14"	127	80	CB4450-0350
400	16"	140	115	CB4450-0400
450	18"	152	145	CB4450-0450
500	20"	152	175	CB4450-0500
600	24"	178	245	CB4450-0600

## CB4435 | CB4439 | CB4438

## ASA 150

## Clapet double battant ASA150

Dual plate check valve ASA150

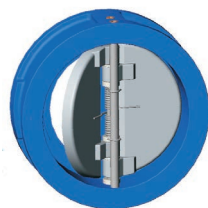

Corps : Fonte Ductile GGG40  
 Raccordement : Entre brides ASA150Lbs  
 Pression de service : 20 bar  
 Température de service max : +100°C

Body: Ductile Iron GGG40  
 Connection: Between flanges ASA150Lbs  
 Working pressure: 20 bar  
 Maximum working temperature: +100°C



DN		L (mm)	Kg	Ref.
mm	inch			
50	2"	43	1,3	CB4435-0050
65	2" 1/2	46	1,8	CB4435-0065
80	3"	64	3,5	CB4435-0080
100	4"	64	4	CB4435-0100
125	5"	70	6	CB4435-0125
150	6"	76	8,5	CB4435-0150
200	8"	89	15	CB4435-0200
250	10"	114	28	CB4439-0250
300	12"	114	37	CB4439-0300
350	14"	127	52	CB4439-0350
400	16"	140	75	CB4439-0400
450	18"	152	95	CB4438-0450
500	20"	152	125	CB4438-0500
600	24"	178	180	CB4438-0600

**Battant : Acier A216WCB chromé**  
**Joint : NBR**

**Plate : Steel A216WCB**  
**Seal : NBR**

**Battant : CF8M**  
**Joint : EPDM**

**Plate : CF8M**  
**Seal : EPDM**

**Battant : Fonte GGG40**  
**Joint : NBR**

**Plate : Iron GGG40**  
**Seal : NBR**

## CB3442

## Battant bronze aluminium | Aluminium bronze plate

## Clapet double battant PN16 – battant bronze aluminium

Ductile iron dual plate swing check valve PN16 – aluminium bronze plate



Corps : Fonte Ductile EN-GJS-400-15  
 Battant : Bronze aluminium  
 Axe : Inox 316  
 Ressorts : Inox 316  
 Etanchéité : NBR vulcanisé  
 Raccordement : Entre brides PN10/16  
 Pression de service : 16 bar  
 Température de service max : +80°C

Body: Ductile Iron EN-GJS-400-15  
 Plate: Aluminium bronze  
 Shaft: Stainless steel 316  
 Springs: Stainless steel 316  
 Seal: NBR  
 Connection: Between flanges PN10/16  
 Working pressure: 16 bar  
 Working temperature: +80°C

DN		L (mm)	Kg	Ref.
mm	inch			
50	2"	54	1,65	CB3442-0050
65	2" 1/2	54	2,4	CB3442-0065
80	3"	57	3,1	CB3442-0080
100	4"	64	4,85	CB3442-0100
125	5"	70	6,4	CB3442-0125
150	6"	76	9,1	CB3442-0150
200	8"	95	16,9	CB3442-0200
250	10"	108	27,5	CB3442-0250
300	12"	144	35,9	CB3442-0300
350	14"	184	81	CB3442-0350



## CB6442

## Inox PN16 | Stainless steel PN16

## Clapet double battant PN16 - inox

Dual plate check valve [PN16 - Stainless steel](#)

Corps et battant : Inox 316  
 Axe : Inox 316  
 Etanchéité : FPM  
 Raccordement :  
 DN50-200 : entre brides PN25  
 DN250-600 : entre brides PN10/16  
 Pression de service max :  
 DN50 à DN300 : 16 bar  
 DN350 à DN600 : 10 bar  
 Température de service : -10°C/+180°C

Body and plate: Stainless steel 316  
 Shaft: Stainless steel 316  
 Seal: FPM  
 Connection:  
 DN50-200: between flanges PN25  
 DN250-600: between flanges PN 10/16  
 Working pressure:  
 DN50-300: 16 bar  
 DN350-600: 10 bar  
 Working temperature: -10°C/+180°C

DN		PS	L (mm)	Kg	Ref.
mm	inch				
50	2"	16	54	1,84	CB6442-0050
65	2" 1/2	16	54	2,04	CB6442-0065
80	3"	16	57	3,35	CB6442-0080
100	4"	16	64	5,05	CB6442-0100
125	5"	16	70	6,68	CB6442-0125
150	6"	16	76	9,6	CB6442-0150
200	8"	16	95	18,07	CB6442-0200
250	10"	16	108	26,9	CB6442-0250
300	12"	16	144	38,9	CB6442-0300
350	14"	10	184	80	CB6442-0350
400	16"	10	191	106	CB6442-0400
450	18"	10	203	128	CB6442-0450
500	20"	10	213	158	CB6442-0500
600	24"	10	222	225	CB6442-0600

## CB6450

## Inox PN25 | Stainless steel PN25

## Clapet double battant PN25 - inox

Dual plate swing check valve [PN25 - Stainless steel](#)

Corps et battant : Inox 316  
 Axe : Inox 316  
 Etanchéité : FPM  
 Raccordement : Entre-Brides PN25  
 Pression de service : 25 bar  
 Température de service max : +200°C

Body and plate: Stainless steel 316  
 Shaft: Stainless steel 316  
 Seal: FPM  
 Connection: Between flanges PN25  
 Working pressure: 25 bar  
 Maximum working temperature: +200°C

\* sur demande / on request

DN		L (mm)	Kg	Ref.
mm	inch			
50	2"	43	1,2	CB6450-0050
65	2" 1/2	46	1,9	CB6450-0065
80	3"	64	3	CB6450-0080
100	4"	64	4	CB6450-0100
125	5"	70	6	CB6450-0125
150	6"	76	8,5	CB6450-0150
200	8"	89	15	CB6450-0200
250	10"	114	*	CB6450-0250
300	12"	114	*	CB6450-0300
350	14"	127	56	CB6450-0350
400	16"	140	73	CB6450-0400
450	18"	152	98	CB6450-0450
500	20"	152	127	CB6450-0400
600	24"	178	193	CB6450-0600



## CLAPETS À SOUPE LIFT CHECK VALVES

### CS2142 | CS2143

#### Clapet de retenue à soupape à chapeau union femelle BSP

Femelle BSP union cap lift check valve



Corps : Bronze  
Clapet : Inox ASTM A182 F316L  
Ressort : Inox 303  
Étanchéité :  
CS2142 Inox  
CS2143 PTFE  
Raccordement : Femelle BSP  
Pression de service max : 25 bar  
Température de service max :  
-10°C/+180°C

Body: Bronze  
Disc: Stainless steel ASTM A182 F316L  
Spring: Stainless steel 303  
Seal:  
CS2142 Stainless steel  
CS2143 PTFE  
Connection: Female BSP  
Maximum working pressure: 25 bar  
Maximum working temperature:  
-10°C/+180°C



**Montage toutes positions grâce au ressort.**  
**Mountable in all positions thanks to the spring.**

DN		L (mm)	Kg	Ref.
mm	inch			
8	1/4"	46	0,197	CS2142-0008 CS2143-0008
10	3/8"	46	0,202	CS2142-0010 CS2143-0010
15	1/2"	56	0,281	CS2142-0015 CS2143-0015
20	3/4"	62	0,504	CS2142-0020 CS2143-0020
25	1"	74	0,727	CS2142-0025 CS2143-0025
32	1"1/4	91	1,164	CS2142-0032 CS2143-0032
40	1"1/2	100	1,504	CS2142-0040 CS2143-0040
50	2"	128	2,508	CS2142-0050 CS2143-0050

### CS3240

#### Clapet à soupape à brides PN16

Flanged type lift check valve PN16



Corps : Fonte GG25  
Obturbateur : Fonte GG25  
Ressort : Inox 304  
Étanchéité : Inox  
Raccordement : A brides PN16  
Pression de service : 16 bar  
Température de service max :  
+120°C (16 bar)/+225°C (12 bar)

Body: Cast Iron GG25  
Disc: Cast iron GG25  
Spring: Stainless steel 304  
Seal: Stainless steel  
Connection: Flanged PN16  
Maximum working pressure: 16 bar  
Maximum working temperature:  
+120°C (16 bar)/+225°C (12 bar)



**Montage toutes positions grâce au ressort**  
**Mountable in all positions thanks to the spring**

DN		L (mm)	Kg	Ref.
mm	inch			
15	1/2"	130	2,2	CS3240-0015
20	3/4"	150	3,3	CS3240-0020
25	1"	160	3,8	CS3240-0025
32	1"1/4	180	5,5	CS3240-0032
40	1"1/4	200	6,9	CS3240-0040
50	2"	230	8,7	CS3240-0050
65	2" 1/2	290	15	CS3240-0065
80	3"	310	20	CS3240-0080
100	4"	350	25	CS3240-0100
125	5"	400	40	CS3240-0125
150	6"	480	55	CS3240-0150
200	8"	600	88	CS3240-0200
250	10"	730	196	CS3240-0250
300	12"	850	300	CS3240-0300

### CS5261S1

#### Clapet à soupape à brides PN40

Flanged type lift check valve PN40



Corps : Acier GP240GH  
Chapeau : Acier GP240GH  
Obturbateur : Inox 304  
Joint : Graphite  
Raccordement : A brides PN40  
Pression de service max : 40 bar  
Température de service max : 180°C

Body: Steel GP240GH  
Bonnet: Steel GP240GH  
Disc: Stainless steel 304  
Gasket: Graphite  
Connection: Flanged PN40  
Maximum working pressure: 40 bar  
Maximum working temperature: 180°C

**NEW**



**Montage toutes positions grâce au ressort**  
**Mountable in all positions thanks to the spring**

DN		L (mm)	Kg	Ref.
mm	inch			
25	1"	160	4,5	CS5261S1-0025
32	1"1/4	180	5,5	CS5261S1-0032
40	1"1/4	200	9	CS5261S1-0040
50	2"	230	11	CS5261S1-0050
65	2" 1/2	290	15	CS5261S1-0065
80	3"	310	24	CS5261S1-0080
100	4"	350	32	CS5261S1-0100
125	5"	400	48	CS5261S1-0125
150	6"	480	65	CS5261S1-0150





CLAPETS D'EXTREMITÉ  
TERMINAL CHECK VALVES



Empêche le retour des eaux dans la conduite.  
Prevents water backflow in the pipe.

CBT6206 | CBT6209A

Clapet d'extrémité acier inoxydable  
Stainless steel terminal check valve



Corps : Acier inoxydable 304  
Battant : Acier inoxydable 304  
Étanchéité : EPDM  
Raccordement :  
DN200-500 : à brides PN10  
DN600-2000 : à brides PN2,5  
Pression de service max : 0,5 bar  
Température de service max : 120°C

Body: Stainless steel 304  
Disc: Stainless steel 304  
Seal: EPDM  
Connection:  
DN200-500: flanged PN10  
DN600-2000: flanged PN2,5  
Maximum working pressure: 0,5 bar  
Maximum working temperature: 120°C



Étanchéité optimale  
Optimal sealing

DN			L (mm)	Acier inoxydable 304	Acier inoxydable 316
mm	inch	Ref.		Ref.	
200	8"	340		CBT6206-0200	CBT6209A-0200
300	12"	440		CBT6206-0300	CBT6209A-0300
400	16"	540		CBT6206-0400	CBT6209A-0400
500	20"	640		CBT6206-0500	CBT6209A-0500
600	24"	740		CBT6206-0600	CBT6209A-0600
700	28"	840		CBT6206-0700	CBT6209A-0700
800	32"	940		CBT6206-0800	CBT6209A-0800
900	36"	1040		CBT6206-0900	CBT6209A-0900
1000	40"	1140		CBT6206-1000	CBT6209A-1000
1100	44"	*		CBT6206-1100	CBT6209A-1100
1200	48"	*		CBT6206-1200	CBT6209A-1200
1300	50"	*		CBT6206-1300	CBT6209A-1300
1400	56"	*		CBT6206-1400	CBT6209A-1400
1500	60"	*		CBT6206-1500	CBT6209A-1500
1600	64"	*		CBT6206-1600	CBT6209A-1600
1700	66"	*		CBT6206-1700	CBT6209A-1700
1800	72"	*		CBT6206-1800	CBT6209A-1800
2000	80"	*		CBT6206-2000	CBT6209A-2000

\* sur demande / on request

CBT9200

Clapet d'extrémité polyamide  
Terminal check valve polyamide



Corps + battant : Polyamide renforcé à 20% de fibres de verre recyclable  
Ancrages mécaniques : Inox AISI 316  
Joints (battants + corps) : EPDM  
Raccordement : Brides ISO PN10  
Tenue à la pression : 1 bar (10 mCE)  
Température de service max : 70°C  
Se fixe:

- sur toute paroi béton verticale à l'aide de 4 ancrages mécaniques fournis.  
- sur bride de canalisation PN10 (visserie non fournie).

Body + disc: 20% Glass fiber reinforced polyamide recyclable  
Shaft: Stainless Steel AISI 316  
Seals: EPDM  
Connection: Flanged ISO PN10  
Maximum working pressure: 1 bar (10 mCE)  
Maximum working temperature: 70°C  
Setting:  
- mounts on all types of vertical concrete walls with the 4 included mechanical anchors.  
- mounts on pipe flanges PN10 (screws not included).



Étanchéité optimale grâce à son joint mousse (contre la paroi) et son joint à lèvres.  
Optimal sealing thanks to its foam gasket (against the wall) and its seal.

DN		L (mm)	Kg	Ref.
mm	inch			
100	4"	45	0,4	CBT9200-0100
150	6"	55	0,6	CBT9200-0150
200	8"	65	0,9	CBT9200-0200

CBT9200A

Clapet d'extrémité polyester  
Terminal check valve polyester



Corps + battant : Résine polyester renforcée de fibre de verre  
Ancrages mécaniques : Inox AISI 316  
Joints : EPDM  
Raccordement : Brides ISO PN10 (à percer)  
Pression max de service : 1 bar  
Tenue à la pression : 1 bar (10 mCE)  
Température de service max : 70°C  
Se fixe:  
- sur toute paroi verticale (chevilles à frapper Inox 316 fournis).  
- sur bride normalisée (visserie non fournie, perçage en option surcôté).

Body + disc: Reinforced polyester resin with glassfiber  
Shaft: Stainless steel AISI 316  
Seals: EPDM  
Connection: Flanged ISO PN10 (to drill)  
Maximum service pressure: 1 bar  
Pressure resistance: 1 bar (10 mCE)  
Maximum working temperature: 70°C  
- on vertical concrete walls (screws 316 included).  
- on standardized flange (screws not included, extra cost for drilling).

DN		L (mm)	Kg	Ref.
mm	inch			
200	4"	150	1,6	CBT9200A-0200
250	10"	160	2	CBT9200A-0250
300	12"	189	3,7	CBT9200A-0300
400	16"	206	6,5	CBT9200A-0400
500	20"	240	9,7	CBT9200A-0500
600	24"	280	14,3	CBT9200A-0600
800	32"	525	25	CBT9200A-0800
1000	40"	535	102	CBT9200A-1000
1200*	48"	695	151	CBT9200A-1200
1400*	56"	800	236	CBT9200A-1400
1500*	60"	870	285	CBT9200A-1500

\* Le perçage pour fixation sur bride ISO PN10 n'est pas réalisable pour les DN1200 / 1400 / 1500.

Drilling for mounting on ISO PN10 flange is not possible for DN1200/1400/1500.



Protection contre les refoulements.  
Léger et résistant (corrosion, UV, eau de mer ...).  
Prevents water backflow.  
Lightweight and resistant (to corrosion, UV, seawater, etc.).



## CLAPETS À PAPILLON TILTING CHECK VALVES

### CP4243 | CP4243A

Clapet à papillon à brides à contrepoids  
Tilting type check valve with counterweight



Corps : Fonte ductile EN-GJS-500-7 (GGG50)  
Obturateur : Fonte ductile EN-GJS-500-7 (GGG50)  
Siège : Inox 304  
Étanchéité : EPDM  
Raccordement : À brides PN10/16  
Pression de service : 16 bar  
Température de service : -10°C / +80°C

Body: Ductile iron EN-GJS-500-7 (GGG50)  
Disc: Ductile iron EN-GJS-500-7 (GGG50)  
Seat: Stainless Steel 304  
Seal: EPDM  
Connection: Flanged PN10/16  
Working pressure: 16 bar  
Working temperature: -10°C / +80°C



**PN25-40 sur demande**  
**PN25-40 on request**



**Inversion possible du contre-poids**  
**Possible to reverse of the counterweight**

				Clapet et contrepoids Valve with counterweight	Avec capot protection With protection guard*
DN		L (mm)	Kg	Ref.	Ref.
mm	inch				
200	8"	230	45	CP4243-0200	CP4243A-0200
250	10"	250	76	CP4243-0250	CP4243A-0250
300	12"	270	102	CP4243-0300	CP4243A-0300
350	14"	290	140	CP4243-0350	CP4243A-0350
400	16"	310	176	CP4243-0400	CP4243A-0400
450	18"	330	245	CP4243-0450	CP4243A-0450
500	20"	350	300	CP4243-0500	CP4243A-0500
600	24"	390	432	CP4243-0600	CP4243A-0600
700	28"	430	565	CP4243-0700	CP4243A-0700
800	32"	470	833	CP4243-0800	CP4243A-0800
900	36"	510	1081	CP4243-0900	CP4243A-0900
1000	40"	550	1268	CP4243-1000	CP4243A-1000
1200	48"	630	2127	CP4243-1200	CP4243A-1200

**NEW**

**\*CP4243A**

**Prix de la vanne complète avec capot de protection Inox 304 inclus pour plus de sécurité.**  
**Price of valve complete with stainless steel 304 protective cover for better safety.**

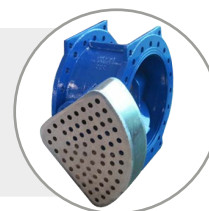

### CP4208 | CP4248

Clapet à papillon à brides à contrepoids avec vérin hydraulique  
Tilting type check valve with counterweight and hydraulic damper



Corps et papillon : Fonte ductile GGG50  
Siège : Acier inoxydable 304  
Axe de manoeuvre : Acier inoxydable 420  
Joint : EPDM  
Raccordement : À brides PN10 ou PN16  
Température de service : -10°C / +80°C  
Avec levier, contrepoids et vérin hydraulique

Body and Disc: Ductile iron GGG50  
Seat: Stainless steel 304  
Shaft: Stainless steel 320  
Sealing ring: EPDM  
Connection: Flanged PN10 or PN16  
Working temperature: -10°C / +80°C  
With lever, counterweight and hydraulic damper

**NEW**

				PN10	PN16
DN		L (mm)	Kg	Ref.	Ref.
mm	inch				
350	14"	290	225	CP4208-0350	CP4248-0350
400	16"	310	270	CP4208-0400	CP4248-0400
450	18"	330	324	CP4208-0450	CP4248-0450
500	20"	350	385	CP4208-0500	CP4248-0500
600	24"	390	513	CP4208-0600	CP4248-0600
700	28"	430	678	CP4208-0700	CP4248-0700
800	32"	470	891	CP4208-0800	CP4248-0800
900	36"	510	1243	CP4208-0900	CP4248-0900
1000	40"	550	1586	CP4208-1000	CP4248-1000
1200	48"	630	2623	CP4208-1200	CP4248-1200



**Avec levier contrepoids et vérin hydraulique - amortissement sur la fermeture.**  
**With lever, counterweight and hydraulic damper - damping during closure.**



**Prévoir de rajouter de l'huile hydraulique pour le vérin (type YB-N46 ou similaire).**  
**Add Hydraulic oil (type YB-N46 or equivalent).**



Contactez-nous pour toute demande de position verticale; nous préciser la position du clapet lors de votre demande (position livrée en horizontal en standard) ainsi que l'environnement amont/aval du clapet pour vous préconiser l'équipement le plus adapté.

Contact us for any vertical position requests: please specify the position of the check valve (position delivered horizontally as standard) as well as the upstream / downstream environment of the check valve to recommend the most suitable equipment.





**DISCONNECTEURS  
BACKFLOW PREVENTERS**



**Le disconnecteur prévient tout dysfonctionnement du réseau et garantit une excellente qualité de l'eau. En cas de changement de pression, il permet un arrêt automatique de la distribution d'eau.**

**The backflow preventer warns of any dysfunction in the network and guarantees excellent water quality. In case of a reversal in pressure, it automatically stops the distribution of water. The polluted fluid is isolated then disposed into the network of water to discharge.**

**X2101**

Disconnecteur femelle BSP - à zone de pression différente non contrôlable (type CA 573)

Female BSP backflow preventer - non-controllable different pressure area - CA 573 type



Corps et siège : Laiton  
Obturbateur : POM  
Joint et membrane : NBR  
Raccordement : Femelle BSP  
Pression de service max : 10 bar  
Température de service : +5°C/+65 °C

Body & Seat: Brass  
Disc: POM  
Gasket & membrane: NBR  
Connection: Female BSP  
Maximum working pressure: 10 bar  
Working temperature: +5°C/+65 °C

DN		L (mm)	Kg	Ref.
mm	inch			
15	1/2"	121	0,59	X2101-0015
20	3/4"	151	0,66	X2101-0020



**X2102**

Disconnecteur type "BA" mâle BSP - à zone de pression réduite contrôlable (type BA 574)

Male BSP backflow preventer "BA" type - controllable reduced pressure area - BA 574 type



Corps et chapeau :  
Laiton du 1/2" au 1"1/4"  
Bronze du 1"1/2" au 2"  
Obturbateurs : Laiton  
Axe : Inox  
Membrane : EPDM  
Joints : NBR  
Raccordement : Mâle BSP  
Pression de service max : 10 bar  
Température de service : +5°C / +65 °C

Body & bonnet :  
Brass from 1/2" up to 1"1/4"  
Bronze from 1"1/2" up to 2"  
Disc: Brass  
Stem: Stainless steel  
Membrane: EPDM  
Gaskets: NBR  
Connection: Male BSP  
Maximum working pressure: 10 bar  
Working temperature: +5°C/+65 °C

DN		L (mm)	Kg	Ref.
mm	inch			
15	1/2"	173	1,06	X2102-0015
20	3/4"	200	1,8	X2102-0020
25	1"	262	3,7	X2102-0025
32	1"1/4"	277	5	X2102-0032
40	1"1/2"	330	7	X2102-0040
50	2"	396	9,8	X2102-0050



**X2203**

Disconnecteur à brides - à zone de pression réduite contrôlable (type BA 575)

Flanged backflow preventer - controllable reduced pressure area - BA575 type



Corps et chapeau : Bronze  
Obturbateurs : Laiton  
Ressort : Inox  
Membrane : EPDM  
Joints : NBR  
Raccordement : À brides PN10  
Pression de service max : 10 bar  
Température de service : +5°C/+65 °C

Body & bonnet: Bronze  
Disc: Brass  
Spring: Stainless steel  
Membrane: EPDM  
Gaskets: NBR  
Connection: Flanged PN10  
Maximum working pressure: 10 bar  
Working temperature: +5°C/+65 °C

DN		L (mm)	Kg	Ref.
mm	inch			
65	2"1/2"	305	17	X2203-0065
80	3"	470	26,5	X2203-0080
100	4"	470	28	X2203-0100



### CLAPETS CHECK VALVES

#### GÉNÉRALITÉS

Respecter le sens de montage des clapets. (Voir Fig. 36)  
Respecter les correspondances de DN entre le clapet et la tuyauterie. Respecter les distances minimales d'implantation. (Voir Fig. 37)  
Respecter les cycles d'utilisations, éviter les régimes pulsatoires et les utilisations anormales du clapet. (Voir Fig. 37)

#### LIMITES D'UTILISATION

L'utilisateur doit s'assurer de l'utilisation du matériel dans les bonnes conditions de service (Pression, température et nature du fluide) préconisées sur la documentation TECOFI et les plaques de marquage. Les températures d'utilisation des clapets, vis-à-vis du fluide, dépendent du matériau des joints de siège ou de la boule.  
Se conformer au marquage de la plaque signalétique CE, qui définit les températures minimums et maximales de service (TS).

#### CLAPETS À BOULE

Pour DN > 250 : montage hors axe avec décalage possible afin de diminuer les coups de bélier lors de la descente de la boule. (Voir Fig. 35)  
Dans le cas d'un montage horizontal, attention à l'utilisation sous faible charge (fermeture de la boule).  
Étanchéité relative sur eau claire.  
Sur les clapets à boule, le bouchon de dégazage permet de décoller manuellement la boule, en régime de fonctionnement.  
Montage sur fluide descendant interdit. (Voir Fig. 36)

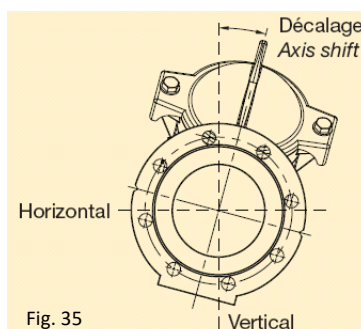

Fig. 35

- A partir du DN 300 l'inclinaison du clapet par rapport à la verticale permet de diminuer le risque de coup de bélier grâce à une descente plus lente de la boule.

- From DN300 the check valve inclination to the vertical allows decreasing the risk of water hammer thanks to a slower descent of the ball.

#### CLAPETS SIMPLE BATTANT

Monter le clapet en utilisant le crochet pour la préhension. Lors d'un montage horizontal, l'axe du crochet matérialise l'axe vertical de la tuyauterie. (Voir Fig. 36)

#### CLAPETS DOUBLE BATTANT

S'assurer du bon fonctionnement des ressorts de rappel.  
DN > 150 : montage sur fluide descendant fortement déconseillé. (Voir Fig. 36)  
Lors d'un montage horizontal, l'axe du clapet doit être vertical. (Voir Fig. 36)

#### GENERALITIES

Respect the assembly direction. (See Fig. 35)  
Respect the correlation between the DN of the check valve and piping.  
Respect the minimum distances of installation. (See Fig. 37)  
Respect the cycles of uses. Avoid the pulsed operations and the abnormal uses of the check valve. (See Fig. 37)

#### TERMS OF USE

The user must follow the working conditions of the equipment (Pressure, temperature and nature of fluid) recommended on TECOFI documentation and the valve marking. The temperatures of use of the check valves, the fluid, depending on the material of the seat and the ball.  
Conform to the marking of the CE nameplate, which defines the minimum and maximum temperatures of service (TS).

#### BALL CHECK VALVES

For DN > 250: possible assembly with axis shift in order to decrease the water hammers when ball descends. (See Fig. 35)  
In the case of horizontal assembly, be careful on using under low pressure (closing of ball). Relative tightness for clear water.  
On ball check valves, the vent plug makes it possible to remove manually the ball during operation.  
Assembly is not possible with a downward flow. (See Fig. 36)

#### SANDWICH CHECK VALVE

Mount the valve using the hook.  
In the case of horizontal assembly, the hook should be vertical to the piping. (See Fig. 36)

#### DUAL PLATE CHECK VALVE

Insure the correct operation of the return springs.  
DN > 150: assembly is not possible with downward flows. (See Fig. 36)  
When assembling horizontally, the axis of the check valve must be vertical. (See Fig. 36)



### POSITION DES CLAPETS ET SENS DE MONTAGE

Veillez à un montage conforme au sens de la flèche.

### VALVE POSITION AND ASSEMBLY

Please assemble the valve following the arrow.

#### Clapet à double battant / Dual plate check valve

##### Horizontal

Pour un montage horizontal, l'axe du clapet doit être vertical.  
For horizontal assembly, the axis should be placed in the vertical position.

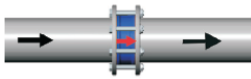

##### Vertical

Pour un montage vertical, le sens d'ouverture des battants du clapet doit correspondre à la direction du fluide.

*When assembling in the vertical position, the opening direction of the plates has to be in accordance to the direction of the fluid.*

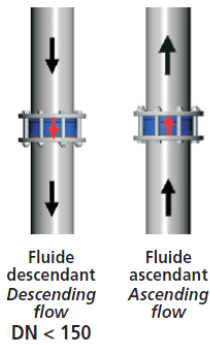

Fluide descendant  
Descending flow  
DN < 150

Fluide ascendant  
Ascending flow

#### Clapet à battant / swing check valve

##### Vertical

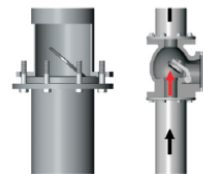

OUI  
YES

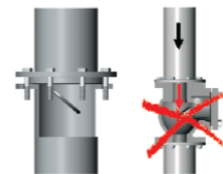

NON  
NO

Fluide ascendant  
Ascending flow

Fluide descendant  
Descending flow

##### Horizontal

Pour un montage horizontal, l'axe du clapet (matérialisé par le crochet) doit être à la verticale.

*For assembly in the horizontal position, ensure the axis is placed in the vertical position (ensured when hook is positioned vertically).*

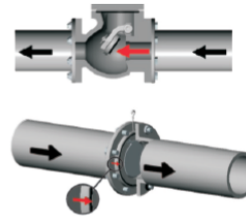
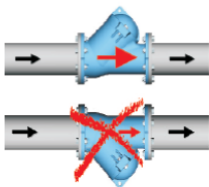

FIG. 36

#### Clapet à boule / ball check valve

##### Horizontal



OUI  
YES

NON  
NO

##### Vertical

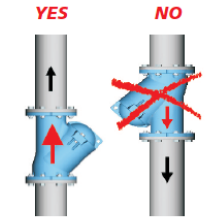

OUI  
YES

NON  
NO

Fluide ascendant  
Ascending flow

Fluide descendant  
Descending flow

#### Clapet axial / Axial check valve

Montage toutes positions ;  
fluide ascendant ou descendant.  
*Mounting in all positions ; ascending  
flow or descending flow.*

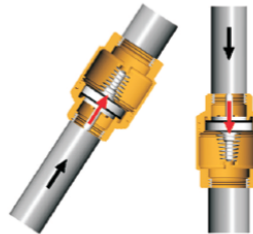
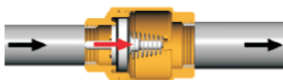

#### Clapet à soupape / lift check valve

Montage toutes positions ;  
fluide ascendant ou descendant.  
*Mounting in all positions ; ascending  
flow or descending flow.*

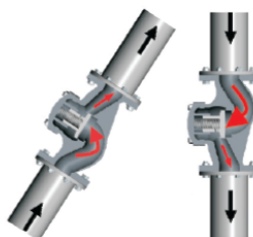
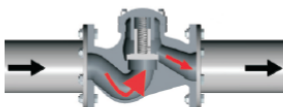

#### ATTENTION AUX DISTANCES !

Une distance minimale doit être respectée entre le clapet et tout élément perturbateur : coude, divergent ou appareil de robinetterie.

Distance minimale :  
- en amont du clapet : 6DN ;  
- en aval du clapet : 2DN.

#### ATTENTION TO DISTANCES !

A minimum distance must be respected between the check valve and any disruptive element : elbow, reducer or any valve.

Minimum distance :  
- upstream : 6DN ;  
- downstream : 2DN.

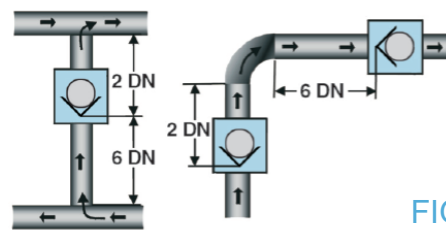

DN : Diamètre Nominal / Nominal Diameter

FIG. 37

#### RESPECTER LE CYCLE D'UTILISATION

Eviter les régimes pulsatoires et les utilisations anormales du clapet.

#### RESPECT CYCLES OF USES

Avoid the pulsed operations and abnormal uses of check valve.

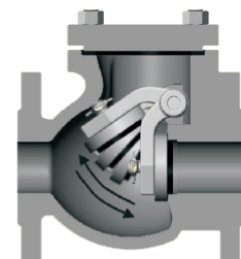





# NOTICE D'INSTALLATION ET D'UTILISATION USE AND INSTALLATION NOTE



CLAPET/FILTRE  
CHECK VALVE/ STRAINER

## TABLES DES MATÉRIAUX / MATERIAL CHART

	Clapets axiaux Axial check valves			Clapets à battant Swing check valves		Clapets à soupape Lift check valves		Clapets à boule Ball check valves		Clapets à papillon Tilting check valves		Filtres Strainers	
	Corps Body	Obturateur Disc	Etanchéité Tightness	Corps et battant Body & disc	Etanchéité Tightness	Corps et chapeau Body & bonnet	Etanchéité Tightness	Corps et chapeau Body & cover	Boule Ball	Corps et battant Body & disc	Etanchéité Tightness	Corps et chapeau Body & bonnet	Tamis Screen
Fonte / Cast iron EN-GJL-250	✓	✓	✓	✓		✓						✓	
Fonte GS / Ductile iron EN-GJS-400-15	✓	✓		✓				✓		✓		✓	
Inox / Stainless steel (316)	✓	✓	✓	✓	✓		✓	✓				✓	✓
Inox / Stainless steel (304)					✓								✓
Inox X20Cr13 (inox 420)		✓	✓				✓						
Acier / Cast steel				✓		✓						✓	
Bronze				✓	✓	✓						✓	
Laiton / Brass	✓			✓	✓							✓	
PTFE			✓		✓		✓						
Nitrile			✓		✓				✓				
EPDM			✓		✓				✓		✓		
FPM (type Viton)					✓								

✓ Disponible en standard / Standard construction

Raccordement / Connection							
ISO PN 10	✓		✓		✓	✓	✓
ISO PN 16	✓		✓		✓	✓	✓
ISO PN 20 ASA 150	✓		✓		✓		✓
ISO PN 40	✓		✓		✓	✓	✓
Taraudé gaz / Threaded BSP	✓		✓		✓	✓	✓

✓ Disponible en standard / Standard construction

Nature du fluide / Fluid type						
Eau claire / Clear water	★ ★ ★	★ ★ ★	★ ★	★ ★	★ ★ ★	★ ★ ★
Eau chargée / Waste water		★		★ ★ ★	★	★ ★
Gaz / Gas	★ ★	★ ★	★ ★ ★			★ ★ ★
Vapeur / Steam	★ ★ ★		★ ★ ★			★ ★ ★
Fluide agressif Corrosive fluid	★ ★ ★	★ ★ ★	★ ★ ★	★ ★		★ ★ ★

★★★ Préconisé / Designed for

★★ Acceptable / Acceptable

★ Nous consulter / On request

Position de montage / Assembly position						
Descendant Descending ↓	★	★	★ ★ ★		★	★ ★ ★
Ascendant Ascending ↑	★ ★ ★	★ ★ ★	★ ★ ★	★ ★ ★	★ ★ ★	★
Horizontal ↔	★ ★ ★	★ ★ ★	★ ★ ★	★ ★ ★	★ ★ ★	★ ★ ★

★★★ Préconisé / Designed for

★★ Acceptable / Acceptable

★ Nous consulter / On request

# FOCUS : FILTRE À AIMANT

## MAGNET STRAINER FOCUS

**AIMANTS POUR FIXATION  
DES PARTICULES**

*Magnets to attract  
PARTICLES*

**CORPS EN FONTE  
REVÊTU EPOXY 150µm  
CAST IRON BODY EPOXY  
COATED 150µm**

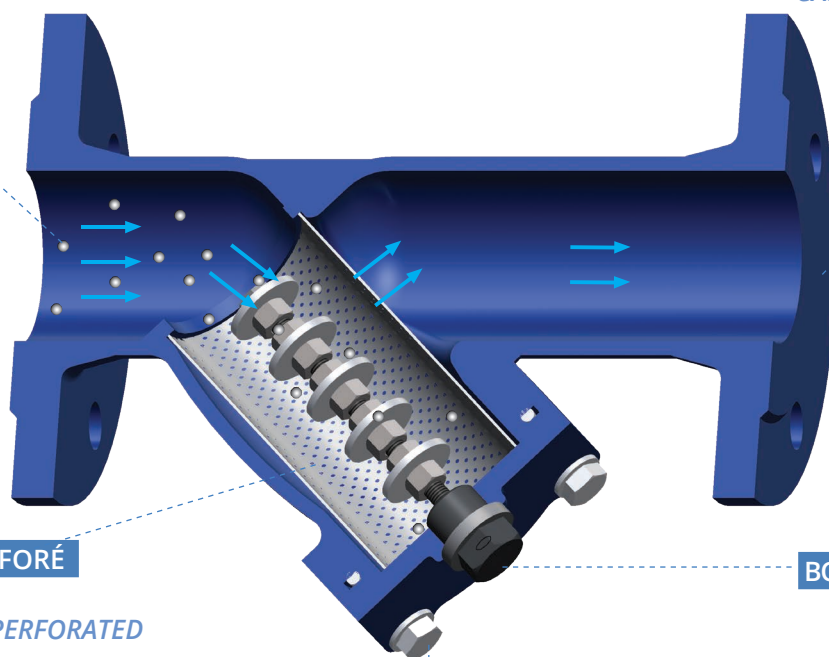

**TAMIS INOX 304 PERFORÉ**

Maille 1 - 1,6mm  
*STAINLESS STEEL 304 PERFORATED  
SCREEN - Mesh 1 - 1,16mm*

**BOUCHON DE VIDANGE  
DRAIN PLUG**

**VISSERIE INOX  
STAINLESS STEEL SCREWS**

**Voir page 188  
See page 188**

### AVANTAGES

Recueille toutes les impuretés qui se trouvent dans l'installation. Élimine les particules métalliques trop fines pour être filtrées mais qui risquent de détériorer les appareils en aval du filtre.

Cela évite également la contamination du process.

Filtre les particules suivantes : fer, acier.

Installations en amont des chaudières recommandées.

### ADVANTAGES

Collects all impurities in the installation. Eliminates metal particles that are too thin to be filtered, but can damage the equipment installed after the strainer.

This also prevents contamination of the process.

Filters the following particles: Iron, Steel.

Installations upstream of boilers recommended.

### ENTRETIEN

Lors du nettoyage du tamis dévisser l'aimant du couvercle pour enlever les particules métalliques accrochées.

### MAINTENANCE

*When cleaning the screen unscrew the magnet from the filter cover to remove the collected metal particles.*



**FILTRES À TAMIS FONTE**  
**CAST IRON STRAINERS**

**F3240S1-EP**

Filtere à tamis Y fonte à brides - PN16

Y strainer cast iron flanged - PN16



Corps :

DN15-300 : Fonte EN-GJL-250 (GG25)  
DN350-400 : Fonte ductile EN-GJS-500 (GGG50)

Tamis : Inox 304

DN15-50 : Maille 1 mm  
DN65-150 : Maille 1,3 mm  
DN200-400 : Maille 1,6 mm

Bouchon de purge : Inox 304

Boulonnerie : Inox 304

Joint : EPDM CH

Raccordement :

DN15-150 : À brides PN10/PN16

DN200-400 : À brides PN16

Pression de service : 16 bar

Température de service max :

-15°C / + 140°C

Body:

DN15-300: Cast iron EN-GJL-250 (GG25)  
DN350-400: Fonte ductile EN-GJS-500 (GGG50)

Screen: Stainless steel 304

DN15-50: Mesh 1 mm

DN65-150: Mesh 1,3 mm

DN200-400: Mesh 1,6 mm

Drain plug: Stainless steel 304

Bolts: Stainless steel 304

Gasket: Heat EPDM

Connection:

DN15-150: Flanged PN10/PN16

DN200-400: Flanged PN16

Working pressure: 16 bar

Maximum working temperature:

-15°C / + 140°C

DN		L (mm)	Kg	Ref.
mm	inch			
15	1/2"	130	3	F3240S1-EP0015
20	3/4"	150	3,2	F3240S1-EP0020
25	1"	160	4	F3240S1-EP0025
32	1"1/4	180	6	F3240S1-EP0032
40	1"1/2	200	7	F3240S1-EP0040
50	2"	230	8	F3240S1-EP0050
65	2"1/2	290	12	F3240S1-EP0065
80	3"	310	14	F3240S1-EP0080
100	4"	350	18	F3240S1-EP0100
125	5"	400	28	F3240S1-EP0125
150	6"	480	40	F3240S1-EP0150
200	8"	600	70	F3240S1-EP0200
250	10"	730	130	F3240S1-EP0250
300	12"	850	170	F3240S1-EP0300
350	14"	980	240	F3240S1-EP0350
400	16"	1100	345	F3240S1-EP0400

**PRODUITS ASSOCIÉS | RELATED PRODUCTS**

**F3240TAMISN-IN**

Tamis pour filtre F3240S1

Screen for F3240S1 strainer

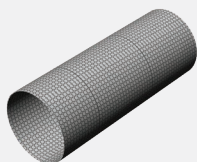

Tamis : Inox 304

DN15-50 : Maille 1 mm  
DN65-150 : Maille 1,3 mm  
DN200-400 : Maille 1,6 mm

Screen: Stainless steel 304

DN15-50: Mesh 1 mm

DN65-150: Mesh 1.3 mm

DN200-400: Mesh 1.6 mm

DN		Ref.
mm	inch	
15	1/2"	F3240TAMISN-IN0015
20	3/4"	F3240TAMISN-IN0020
25	1"	F3240TAMISN-IN0025
32	1"1/4	F3240TAMISN-IN0032
40	1"1/2	F3240TAMISN-IN0040
50	2"	F3240TAMISN-IN0050
65	2"1/2	F3240TAMISN-IN0065
80	3"	F3240TAMISN-IN0080
100	4"	F3240TAMISN-IN0100
125	5"	F3240TAMISN-IN0125
150	6"	F3240TAMISN-IN0150
200	8"	F3240TAMISN-IN0200
250	10"	F3240TAMISN-IN0250V2
300	12"	F3240TAMISN-IN0300V2
350	14"	F3240TAMISN-IN0350
400	16"	F3240TAMISN-IN0400

**F3240JOINTN-EP**

Joint de chapeau pour filtre F3240S1

Bonnet gasket for strainer F3240S1



Joint : EPDM CH

Gasket: Heat EPDM

DN		Ref.	DN		Ref.
mm	inch		mm	inch	
15	1/2"	F3240JOINTN-EP0015	100	4"	F3240JOINTN-EP0100
20	3/4"	F3240JOINTN-EP0020	125	5"	F3240JOINTN-EP0125
25	1"	F3240JOINTN-EP0025	150	6"	F3240JOINTN-EP0150
32	1"1/4	F3240JOINTN-EP0032	200	8"	F3240JOINTN-EP0200
40	1"1/2	F3240JOINTN-EP0040	250	10"	F3240JOINTN-EP0250
50	2"	F3240JOINTN-EP0050	300	12"	F3240JOINTN-EP0300
65	2"1/2	F3240JOINTN-EP0065	350	14"	F3240JOINTN-EP0350
80	3"	F3240JOINTN-EP0080	400	16"	F3240JOINTN-EP0400



F3242

ACS

Filtre à tamis fonte ACS - PN16

ACS cast iron strainer - PN16



**Corps et chapeau :** Fonte EN-GJL-250 (GG25)  
**Tamis :** ASTM A182 F316  
**Tamis démontable maille :**  
 DN40-50 : 1mm  
 DN65-80 : 1,25mm  
 DN100-300 : 1,6 mm  
**Bouchon de vidange :** 1/2" BSP du DN40 au DN125, 3/4" au delà du DN125  
**Etanchéité :** EPDM  
**Raccordement :** A brides PN16 / PN10 DN>200  
**Pression de service max :** 16 bar DN40-200  
 10 bar > DN200  
**Température de service max :** +80°C

**Body, bonnet :** Cast iron EN-GJL-250 (GG25)  
**Screen :** ASTM A182 F316  
**Screen mesh :**  
 DN40-50: 1mm  
 DN65-80: 1.25mm  
 DN100-300: 1.6 mm  
**Drain plug:** 1/2" for DN40 up to DN125  
 3/4" for over DN125  
**Seal:** EPDM  
**Connection:** Flanged PN16 / PN10 DN>200  
**Maximum Working pressure:** 16 bar DN40-200  
 10 bar > DN200  
**Maximum working temperature:** +80°C

DN		L (mm)	Kg	Ref.
mm	inch			
40	1 1/2	200	6,3	F3242-0040
50	2"	230	7,7	F3242-0050
65	2 1/2	290	11,4	F3242-0065
80	3"	310	14,2	F3242-0080
100	4"	350	18,5	F3242-0100
125	5"	400	28,5	F3242-0125
150	6"	480	39,2	F3242-0150
200	8"	600	61,2	F3242-0200
250	10"	730	115,6	F3242-0250
300	12"	850	155,5	F3242-0300

F3230

ASA 150

Filtre à tamis «Y» fonte - ASA150

"Y" type cast iron strainer - ASA150



**Corps :**  
 Fonte EN-GJL-250 (GG25)  
**Tamis :** Inox 304 - Maille 1mm  
**Bouchon de purge :** Acier A105  
**Joint :** Graphite  
**Raccordement :** A brides ASA 150  
**Pression de service :** 16 bar  
**Température de service max :**  
 -10°C / + 200°C

**Body:**  
 Cast iron EN-GJL-250 (GG25)  
**Screen:** Stainless steel 304 - Mesh 1mm  
**Drain plug:** Carbon steel A105  
**Gasket:** Graphite  
**Connection:** Flanged ASA 150  
**Working pressure:** 16 bar  
**Maximum working temperature:**  
 -10°C / + 200°C

DN		L (mm)	Kg	Ref.
mm	inch			
50	2"	230	8	F3230-0050
65	2 1/2	290	12	F3230-0065
80	3"	310	14	F3230-0080
100	4"	350	18	F3230-0100
125	5"	400	32	F3230-0125
150	6"	480	45	F3230-0150
200	8"	600	80	F3230-0200
250	10"	730	130	F3230-0250
300	12"	850	195	F3230-0300

F3240N

Haute température | High temperature

Filtre à tamis fonte - haute température - PN16

Cast iron strainer - high temperature - PN16

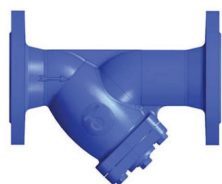

**Corps :**  
 Fonte EN-GJL-250 (DN15-300)  
 Fonte EN-GJS-400 (DN350-400)  
**Tamis :** Inox 304  
**Maille :**  
 DN15-50 : 1mm  
 DN65-150 : 1,3mm  
 DN200-400 : 1,6mm  
**Bouchon de purge :** Acier A105  
**Joint :** Graphite  
**Raccordement :**  
 DN15-150 : À brides PN10/PN16  
 DN200-400 : À brides PN16  
**Pression de service :** 16 bar  
**Température de service :** -10°C/+200°C

**Body:**  
 Cast iron EN-GJL-250 (DN15-300)  
 Ductile iron EN-GJS-400 (DN350-400)  
**Screen:** Stainless steel 304  
**Mesh:**  
 DN15-50: 1mm  
 DN65-150: 1.3mm  
 DN200-400: 1.6mm  
**Drain plug:** Steel A105  
**Gasket:** Graphite  
**Connection:**  
 DN15-150: Flanged PN10/PN16  
 DN200-400: Flanged PN16  
**Working pressure:** 16 bar  
**Working temperature:** -10°C/+200°C

DN		L (mm)	Kg	Ref.
mm	inch			
15	1/2"	130	3	F3240N-0015
20	3/4"	150	3,2	F3240N-0020
25	1"	160	4	F3240N-0025
32	1 1/4	180	6	F3240N-0032
40	1 1/2	200	7	F3240N-0040
50	2"	230	8	F3240N-0050
65	2 1/2	290	12	F3240N-0065
80	3"	310	14	F3240N-0080
100	4"	350	18	F3240N-0100
125	5"	400	32	F3240N-0125
150	6"	480	45	F3240N-0150
200	8"	600	80	F3240N-0200
250	10"	730	130	F3240N-0250
300	12"	850	170	F3240N-0300
350	14"	980	240	F3240N-0350
400	16"	1100	345	F3240N-0400

CHECK VALVE / STRAINER

F3240NA

Avec aimant | With magnet

Filtre à tamis fonte - PN16 - avec aimant  
Cast iron strainer - PN16 - with magnet

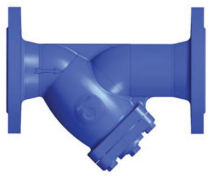

Corps :  
Fonte EN-GJL-250 (DN15-300)  
Fonte EN-GJS-400 (DN350-400)  
Tamis : Inox 304  
Maille :  
DN15-50 : 1mm  
DN65-150 : 1,3mm  
DN200-400 : 1,6mm  
Joint : Graphite  
Raccordement :  
DN15-150 : À brides PN10/PN16  
DN200-400 : À brides PN16  
Pression de service : 16 bar  
Température de service : -10°C/+200°C  
Avec aimant

Body:  
Cast iron EN-GJL-250 (DN15-300)  
Ductile iron EN-GJS-400 (DN350-400)  
Screen: Stainless steel 304  
Mesh:  
DN15-50: 1mm  
DN65-150: 1.3mm  
DN200-400: 1.6mm  
Gasket: Graphite  
Connection:  
DN15-150: Flanged PN10/PN16  
DN200-400: Flanged PN16  
Working pressure: 16 bar  
Working temperature: -10°C/+200°C  
With magnet

DN		L (mm)	Kg	Ref.
mm	inch			
15	1/2"	130	3,1	F3240NA-0015
20	3/4"	150	3,3	F3240NA-0020
25	1"	160	4,1	F3240NA-0025
32	1 1/4"	180	6,1	F3240NA-0032
40	1 1/2"	200	7,1	F3240NA-0040
50	2"	230	8,1	F3240NA-0050
65	2 1/2"	290	12	F3240NA-0065
80	3"	310	14	F3240NA-0080
100	4"	350	18	F3240NA-0100
125	5"	400	32	F3240NA-0125
150	6"	480	45	F3240NA-0150
200	8"	600	80	F3240NA-0200
250	10"	730	130	F3240NA-0250
300	12"	850	170	F3240NA-0300
350	14"	980	250	F4240NA-0350
400	16"	1100	360	F4240NA-0400



Élimine les particules métalliques trop fines pour être filtrées  
Eliminates metal particles that are too thin to be filtered

F4250

PN25

Filtre à tamis fonte - PN25  
Ductile iron strainer - PN25



Corps : Fonte ductile GGG40  
Chapeau : Fonte ductile GGG40  
Tamis : Inox 304  
Maille :  
DN40-65 : 1,5 mm  
DN80-125 : 3 mm  
DN150-700 : 5 mm  
Bouchon de vidange : Bronze  
Boulonnerie : Acier galvanisé  
Joint : EPDM  
Raccordement : A brides PN25  
Pression de service max : 25 bar  
Température de service : -10°C/+80°C

Body: Ductile iron GGG40  
Bonnet: Ductile iron GGG40  
Screen: Stainless steel 304  
Mesh:  
DN40-65: 1.5 mm  
DN80-125: 3 mm  
DN150-700: 5 mm  
Draining plug: Bronze  
Bolts: Galvanized steel  
Gasket: EPDM  
Connection: Flanged PN25  
Maximum working pressure: 25 bar  
Working temperature: -10°C/+80°C

DN		L (mm)	Kg	Ref.
mm	inch			
40	1 1/2"	205	9	F4250-0040
50	2"	217	10	F4250-0050
65	2 1/2"	222	12	F4250-0065
80	3"	264	20	F4250-0080
100	4"	335	34	F4250-0100
125	5"	335	36	F4250-0125
150	6"	433	58	F4250-0150
200	8"	524	95	F4250-0200
250	10"	637	153	F4250-0250
300	12"	762	266	F4250-0300
350	14"	769	288	F4250-0350
400	16"	1025	590	F4250-0400
450	18"	1045	735	F4250-0450
500	20"	1140	800	F4250-0500
600	24"	-	-	F4250-0600

F4260

PN40

Filtre à tamis fonte - PN40  
Ductile iron strainer - PN40



Corps : Fonte ductile GGG40  
Chapeau : Fonte ductile GGG40  
Tamis : Inox 304  
Maille :  
DN40-65 : 1,5 mm  
DN80-125 : 3 mm  
DN150-700 : 5 mm  
Bouchon de vidange : Bronze  
Boulonnerie : Acier galvanisé  
Joint : EPDM  
Raccordement : A brides PN40  
Pression de service max : 40 bar  
Température de service : -10°C/+80°C

Body: Ductile iron GGG40  
Bonnet: Ductile iron GGG40  
Screen: Stainless steel 304  
Mesh:  
DN40-65: 1.5 mm  
DN80-125: 3 mm  
DN150-700: 5 mm  
Draining plug: Bronze  
Bolts: Galvanized steel  
Gasket: EPDM  
Connection: Flanged PN40  
Maximum working pressure: 40 bar  
Working temperature: -10°C/+80°C

DN		L (mm)	Kg	Ref.
mm	inch			
40	1 1/2"	205	9	F4260-0040
50	2"	217	10	F4260-0050
65	2 1/2"	222	12	F4260-0065
80	3"	264	20	F4260-0080
100	4"	335	34	F4260-0100
125	5"	335	36	F4260-0125
150	6"	433	58	F4260-0150
200	8"	524	95	F4260-0200
250	10"	637	153	F4260-0250
300	12"	762	266	F4260-0300
350	14"	769	288	F4260-0350
400	16"	1025	590	F4260-0400
450	18"	1045	735	F4260-0450
500	20"	1140	800	F4260-0500
600	24"	-	-	F4260-0600





**FILTRES À TAMIS LAITON**  
**BRASS STRAINERS**

**F1142**

Filtre à tamis laiton - femelle BSP - PN16  
Female BSP brass strainer - PN16



Corps : Laiton  
Tamis : Inox 304  
Maille : 0,8 mm  
Raccordement : Femelle BSP  
Pression de service : 16 bar  
Température de service max : -20°C / +100°C

Body: Brass  
Screen: Stainless steel 304  
Mesh: 0.8 mm  
Connection: Female BSP  
Working pressure: 16 bar  
Maximum working temperature: -20°C / +100°C

**JUSQU'À ÉPUISEMENT DES STOCKS**  
**WHILE STOCKS LAST**

DN		L (mm)	Kg	Ref.
mm	inch			
15	1/2"	56	0,12	F1142-0015
20	3/4"	68	0,22	F1142-0020
25	1"	77	0,33	F1142-0025
32	1"1/4	94	0,51	F1142-0032
40	1"1/2	105	0,76	F1142-0040
50	2"	125	1,35	F1142-0050

**F1142A**

**ACS**

Filtre à tamis laiton - femelle BSP - PN16 - ACS  
Female BSP brass strainer - PN16 - ACS



Corps : Laiton CW617N  
Tamis : Inox 304  
Joint de couvercle : PTFE  
Raccordement : Femelle BSP  
Pression de service : 16 bar  
Température de service max : -20°C / +100°C

Body: Brass CW617N  
Screen: Stainless steel 304  
Body gasket: PTFE  
Connection: Female BSP  
Working pressure: 16 bar  
Maximum Working temperature: -20°C / +100°C

**ACS**

DN		L (mm)	Kg	Ref.
mm	inch			
15	1/2"	51,38	0,110	F1142A-0015
20	3/4"	63,37	0,165	F1142A-0020
25	1"	67,76	0,260	F1142A-0025
32	1"1/4	88,31	0,520	F1142A-0032
40	1"1/2	100,16	0,680	F1142A-0040
50	2"	120,02	1,049	F1142A-0050

**F1144**

**ACS**

Filtre à tamis laiton - femelle BSP - PN16 - ACS  
Female BSP brass strainer - PN16 - ACS



Corps : Laiton  
Tamis : Inox 304  
Maille : 0,8 mm  
Raccordement : Femelle BSP  
Pression de service : 16 bar  
Température de service max : +120°C

Body: Brass  
Screen: Stainless steel 304  
Mesh: 0.8 mm  
Connection: Female BSP  
Working pressure: 16 bar  
Maximum Working temperature: +120°C

**ACS**

DN		L (mm)	Kg	Ref.
mm	inch			
10	3/8"	48	0,074	F1144-0010
15	1/2"	58	0,135	F1144-0015
20	3/4"	68	0,215	F1144-0020
25	1"	75	0,335	F1144-0025
32	1"1/4	90	0,475	F1144-0032
40	1"1/2	108	0,770	F1144-0040
50	2"	130	1,280	F1144-0050
65	2"1/2	150	2,100	F1144-0065

**F2142**

**ACS avec robinet de purge | ACS with drain valve**

Filtre à tamis laiton avec robinet de purge - femelle BSP - PN16 - ACS  
Female BSP brass strainer with drain valve - PN16 - ACS



Corps : Laiton  
Tamis : Inox 304  
Maille : 0,85 mm  
Raccordement : Femelle BSP  
Pression de service : 16 bar  
Vanne de rinçage : Laiton  
Température de service max : +120°C

Body: Brass  
Screen: Stainless steel 304  
Mesh: 0.85 mm  
Connection: Female BSP  
Working pressure: 16 bar  
Drain valve: Brass  
Maximum Working temperature: +120°C

**ACS**

DN		L (mm)	Kg	Ref.
mm	inch			
15	1/2"	58	0,24	F2142-0015
20	3/4"	68	0,32	F2142-0020
25	1"	75	0,44	F2142-0025
32	1"1/4	90	0,545	F2142-0032
40	1"1/2	108	0,895	F2142-0040
50	2"	130	1,4	F2142-0050



**FILTRES À TAMIS BRONZE**  
**BRONZE STRAINERS**

**F2143**

Filtre à tamis bronze - femelle BSP - PN20  
Female BSP bronze strainer - PN20



Corps : Bronze  
Tamis : Inox 304  
Maille :  
DN15-25 : 0,4 mm  
DN32-50 : 0,5 mm  
Raccordement : Femelle BSP  
Pression de service : 20 bar  
Température de service max : +120°C

Body: Bronze  
Screen: Stainless steel 304  
Mesh:  
DN15-25: 0,4 mm  
DN32-50: 0,5 mm  
Connection: Female BSP  
Working pressure: 20 bar  
Maximum Working temperature: +120°C

**JUSQU'À ÉPUISEMENT DES STOCKS**  
**WHILE STOCKS LAST**

DN		L (mm)	Kg	Ref.
mm	inch			
15	1/2"	58	0,144	F2143-0015
20	3/4"	67,5	0,21	F2143-0020
25	1"	82,5	0,325	F2143-0025
32	1"1/4	91,5	0,484	F2143-0032
40	1"1/2	106,5	0,773	F2143-0040
50	2"	126	1,350	F2143-0050

**F2143W**

Filtre à tamis bronze - femelle/femelle BSP - PN20 - WRAS  
Female BSP bronze strainer - PN20 - WRAS



Corps : Bronze  
Tamis : Inox 304  
Maille :  
DN15-25 : 0,3 mm  
DN32-50 : 0,5 mm  
Joint torique : PTFE  
Raccordement : Femelle/femelle BSP  
Pression de service :  
20 bar (températures ≤ 120°C)  
16 bar (températures > 120°C)  
Température de service : -10°C / + 170°C

Body: Bronze  
Screen: Stainless steel 304  
Mesh:  
DN15-25: 0,3 mm  
DN32-50: 0,5 mm  
O-ring: PTFE  
Connection: Female/female BSP  
Working pressure:  
20 bar (temperatures ≤ 120°C)  
16 bar (temperatures > 120°C)  
Working temperature: -10°C / + 170°C

**BIENTÔT DISPONIBLE**  
**COMING SOON**



DN		L (mm)	Kg	Ref.
mm	inch			
15	1/2"	58	0,184	F2143W-0015
20	3/4"	67,5	0,296	F2143W-0020
25	1"	82,5	0,424	F2143W-0025
32	1"1/4	91,5	0,716	F2143W-0032
40	1"1/2	106,5	0,975	F2143W-0040
50	2"	126	1,493	F2143W-0050



**FILTRES À TAMIS INOX**  
**STAINLESS STEEL STRAINERS**

**F6169 (BSP) | F6769 (NPT)**

Filtre à tamis Y taraudé Inox  
Threaded type "Y" Stainless steel strainer



F6169 DN50 - BSP



Corps : Inox 316  
Tamis : Inox 316  
Joint : PTFE  
Raccordement taraudé :  
F6169-PF : BSP  
F6769-PF : NPT  
Pression de service : 40 bar  
Température de service max :  
-25°C / + 180°C  
ATEX: II 2 GD CT2 :

Body: Stainless steel 316  
Screen: Stainless steel 316  
Bonnet gasket: PTFE  
Connection:  
F6169-PF: BSP threaded  
F6769-PF: NPT threaded  
Working pressure: 40 bar  
Maximum Working temperature:  
-25°C / + 180°C  
ATEX: II 2 GD CT2:

**BIENTÔT DISPONIBLE**  
**COMING SOON**



DN		L (mm)	Kg	Ref.
mm	inch			
08	1/4"	64	0,2	F6169-PF0008 F6769-PF0008
10	3/8"	64	0,2	F6169-PF0010 F6769-PF0010
15	1/2"	64	0,21	F6169-PF0015 F6769-PF0015
20	3/4"	80	0,34	F6169-PF0020 F6769-PF0020
25	1"	90	0,59	F6169-PF0025 F6769-PF0025
32	1"1/4	106	0,8	F6169-PF0032 F6769-PF0032
40	1"1/2	119	1,06	F6169-PF0040 F6769-PF0040
50	2"	140	1,61	F6169-PF0050 F6769-PF0050
65	2"1/2	167	2,99	F6169-PF0065 F6769-PF0065
80	3"	198	4,74	F6169-PF0080 F6769-PF0080
100	4"	238	7,88	F6169-PF0100 F6769-PF0100

**F6240**

Filtre à tamis Y à brides Inox PN16  
Flanged type "Y" Stainless steel strainer PN16



Corps : Inox 316  
Tamis : Inox 304  
Maille :  
DN15-50 : 0,8 mm  
DN65-80 : 1 mm  
DN100-200 : 3 mm  
Joint : PTFE  
Raccordement :  
DN15-150 : À brides PN10/PN16  
DN200-400 : À brides PN16  
Pression de service : 16 bar  
Température de service max :  
-20°C / 200°C

Body: Stainless steel 316  
Screen: Stainless steel 304  
Mesh:  
DN15-50: 0,8 mm  
DN65-80: 1 mm  
DN100-200: 3 mm  
Gasket: PTFE  
Connection:  
DN15-150: Flanged PN10/PN16  
DN200-400: Flanged PN16  
Working pressure: 16 bar  
Maximum Working temperature:  
+20°C / + 200°C

DN		L (mm)	Kg	Ref.
mm	inch			
15	1/2"	130	2	F6240-0015
20	3/4"	150	2,7	F6240-0020
25	1"	160	3,5	F6240-0025
32	1"1/4	180	5	F6240-0032
40	1"1/2	200	6,1	F6240-0040
50	2"	230	8,1	F6240-0050
65	2"1/2	290	12,3	F6240-0065
80	3"	310	15,5	F6240-0080
100	4"	350	22	F6240-0100
125	5"	400	30	F6240-0125
150	6"	480	45,1	F6240-0150
200	8"	600	77,1	F6240-0200



**FILTRES À TAMIS ACIER**  
**STEEL STRAINERS**

**FI5843**

Filtere à tamis acier forgé  
Forged carbon steel "Y" strainer



Corps, chapeau : ASTM A105 N  
Tamis : Inox ASTM A240 316L  
Maille : 0,8 mm  
Etanchéité : Inox 316 + graphite  
Pression de service max : 138 bar  
Température de service max : -29°C/+425°C

Body, bonnet: ASTM A105 N  
Screen: Stainless steel ASTM A240 316L  
Mesh: 0.8 mm  
Seal: Stainless steel 316+ graphite  
Maximum Working pressure: 138 bar  
Maximum working temperature: -29°C/+425°C

DN		L	Kg	BSP	SW	NPT
mm	inch			Ref.	Ref.	Ref.
8	1/4"	90	0,85	FI5843BSP-0008	FI5843SW-0008	FI5843NPT-0008
10	3/8"	90	0,78	FI5843BSP-0010	FI5843SW-0010	FI5843NPT-0010
15	1/2"	90	0,73	FI5843BSP-0015	FI5843SW-0015	FI5843NPT-0015
20	3/4"	110	1,22	FI5843BSP-0020	FI5843SW-0020	FI5843NPT-0020
25	1"	130	1,88	FI5843BSP-0025	FI5843SW-0025	FI5843NPT-0025
32	1"1/4"	160	4,75	FI5843BSP-0032	FI5843SW-0032	FI5843NPT-0032
40	1"1/2"	160	4,45	FI5843BSP-0040	FI5843SW-0040	FI5843NPT-0040
50	2"	160	6,5	FI5843BSP-0050	FI5843SW-0050	FI5843NPT-0050

**F5240**

Filtere à tamis acier PN25/40  
Steel strainer PN25/40



Corps, chapeau : ASTM A 216 WCB  
Tamis : ASTM A182 F304  
Maille :  
DN15-50 : 1 mm  
DN65-80 : 1,25 mm  
DN100-200 : 1,6 mm  
Joint : Graphite  
Raccordement : A brides PN25/40  
DN200 PN40  
Pression de service max : 40 bar  
Température de service max : -20°C/+400°C

Body, bonnet: ASTM A 216 WCB  
Screen: ASTM A182 F304  
Mesh:  
DN15-50: 1 mm  
DN65-80: 1.25 mm  
DN100-200: 1.6 mm  
Gasket: Graphite  
Connection: Flanged PN25/40  
DN200 PN40  
Maximum Working pressure: 40 bar  
Maximum working temperature:  
-20°C/+400°C

DN		L (mm)	Kg	Ref.
mm	inch			
15	1/2"	130	2,65	F5240-0015
20	3/4"	150	3,8	F5240-0020
25	1"	160	4,8	F5240-0025
32	1"1/4"	180	6,9	F5240-0032
40	1"1/2"	200	9,5	F5240-0040
50	2"	230	11,9	F5240-0050
65	2"1/2"	290	16,9	F5240-0065
80	3"	310	22,1	F5240-0080
100	4"	350	31,6	F5240-0100
125	5"	400	54	F5240-0125
150	6"	480	75	F5240-0150
200	8"	600	137	F5240-0200

**FI5241**

**ASA 150**

Filtere à tamis acier à brides - chapeau boulonné - ASA 150  
Flanged steel "Y" strainer bolted bonnet - ASA 150



Corps : Acier ASTM A216 WCB  
Tamis : Inox 304  
Maille :  
DN50 : 1 mm  
DN65-300 : 1.5 mm  
Joint de chapeau : Graphite + inox 304  
Raccordement : A brides ASA 150 LBS  
Pression de service max : 20 bar  
Température de service max :  
-29°C/+425°C

Body: Steel ASTM A216 WCB  
Screen: Stainless steel 304  
Mesh:  
DN50: 1 mm  
DN65-300: 1.5 mm  
Bonnet gasket: Graphite + Stainless Steel 304  
Connection: ASA 150 LBS Flanged  
Maximum Working pressure: 20 bar  
Maximum Working temperature:  
-29°C/+425°C

DN		L (mm)	Kg	Ref.
mm	inch			
50	2"	203	9,7	FI5241-0050
65	2"1/2"	216	23,5	FI5241-0065
80	3"	241	28	FI5241-0080
100	4"	292	37	FI5241-0100
150	6"	406	67	FI5241-0150
200	8"	495	91	FI5241-0200
250	10"	622	135	FI5241-0250
300	12"	699	168	FI5241-0300





**FILTRES À PANIER**  
**BASKET STRAINERS**



Ces filtres sont installés à l'entrée des pompes et avant les compteurs d'eau et les vannes de régulation pour les protéger des débris. Lorsque le changement du tamis est difficile avec un filtre Y, nous vous recommandons le filtre à panier. These strainers are installed between pumps and before water meters and control valves to protect them from debris. If changing the screen of a Y strainer is difficult, we recommend a basket strainer.

**F4206 | F4246 | F4256 | F4266**

**Fonte ductile | Ductile iron**

Filtre à panier fonte ductile  
Strainer basket type ductile iron



Corps : Fonte ductile GGG40  
Tamis : Inox 304  
Maille : 5mm  
Boulonnerie : Acier Inoxydable A2  
Bouchon de purge : Acier Inoxydable 304  
Dimension du trou de purge : 2"  
Joint : Nitrile  
Raccordement : À brides  
Température de service : -10°C/+80°C



Body: Ductile Iron GGG40  
Screen: Stainless steel 304  
Mesh: 5mm  
Bolts: Stainless steel A2  
Drain plug: Stainless steel 304  
Drain dimension: 2"  
O-ring: Nitrile  
Connection: Flanged  
Working temperature: -10°C/+80°C



DN		L (mm)	Kg	PN10	PN16	PN25	PN40
mm	inch			Ref.	Ref.	Ref.	Ref.
100	4"	330	42	voir / see PN16	F4246-0100	F4256-0100	F4266-0100
125	5"	360	56		F4246-0125	F4256-0125	F4266-0125
150	6"	390	73		F4246-0150	F4256-0150	F4266-0150
200	8"	460	122	F4206-0200	F4246-0200	F4256-0200	F4266-0200
250	10"	530	179	F4206-0250	F4246-0250	F4256-0250	F4266-0250
300	12"	630	264	F4206-0300	F4246-0300	F4256-0300	F4266-0300
350	14"	690	305	F4206-0350	F4246-0350	F4256-0350	F4266-0350
400	16"	750	335	F4206-0400	F4246-0400	F4256-0400	F4266-0400
450	18"	810	390	F4206-0450	F4246-0450	F4256-0450	F4266-0450
500	20"	880	569	F4206-0500	F4246-0500	F4256-0500	F4266-0500
600	24"	1000	962	F4206-0600	F4246-0600	F4256-0600	F4266-0600
700	28"	1130	1460	F4206-0700	F4246-0700	F4256-0700	F4266-0700
800	32"	1250	1896	F4206-0800	F4246-0800	F4256-0800	F4266-0800
900	36"	-	-	F4206-0900	F4246-0900	F4256-0900	F4266-0900
1000	40"	1500	2040	F4206-1000	F4246-1000	F4256-1000	F4266-1000



- Grande surface de filtration
- Équipé d'une purge
- Piquage en amont et aval pour manomètre

- Large filtration surface
- Equipped with drain plug
- Holes upstream and downstream for manometers

**F5206 | F5246 | F5256 | F5266**

**Acier Carbone | Carbon steel**

Filtre à panier acier carbone  
Strainer basket type carbon steel



Corps : Acier carbone mécanosoudé  
Tamis : Inox 304  
Maille : 5mm  
Boulonnerie : Acier Inoxydable A2  
Bouchon de purge : Acier Inoxydable 304  
Dimension du trou de purge : 2"  
Raccordement : À brides  
Température de service : -10°C/+80°C



Body: Carbon steel  
Screen: Stainless Steel 304  
Mesh: 5mm  
Bolts: Stainless Steel A2  
Drain plug: Stainless steel 304  
Drain dimension: 2"  
Connection: Flanged  
Working temperature: -10°C/+80°C



DN		L (mm)	Kg	PN10	PN16	PN25	PN40
mm	inch			Ref.	Ref.	Ref.	Ref.
1100	44"	-	-	F5206-1100	F5246-1100	F5256-1100	F5266-1100
1200	48"	1800	2690	F5206-1200	F5246-1200	F5256-1200	F5266-1200





**BOÎTES À BOUE  
H-STRAINERS**

**F4200**

**PN10**

Filtre boîte à boue à brides fonte ductile PN10

Flanged ductile iron H-strainer PN10

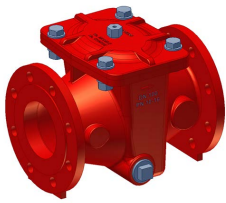

**ACS**



Corps, chapeau : Fonte ductile GGG40  
Grille : Inox 316  
Filtration standard : 2 mm  
Joint : EPDM  
Raccordement : A brides PN10  
Pression de service max : 10 bar  
Température de service max : +80°C

Body, bonnet: Ductile iron GGG40  
Filter: Stainless steel 316  
Standard Mesh: 2 mm  
Seal: EPDM  
Connection: Flanged PN10  
Maximum Working pressure: 10 bar  
Maximum working temperature: +80°C



**Bouchon de purge sur le chapeau  
Drain plug on the bonnet**

DN		L (mm)	Kg	Ref.
mm	inch			
200	8"	500	76	F4200-0200
250	10"	580	165	F4200-0250
300	12"	610	230	F4200-0300
350	14"	650	250	F4200-0350
400	16"	800	410	F4200-0400
450	18"	800	430	F4200-0450
500	20"	950	770	F4200-0500
600	24"	1100	850	F4200-0600

**F4240**

**PN16**

Filtre boîte à boue à brides fonte ductile PN16

Flanged ductile iron H-strainer PN16

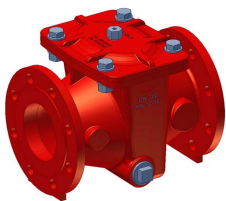

**ACS**



Corps, chapeau : Fonte ductile GGG40  
Grille : Inox 316  
Filtration standard : 2 mm  
Joint : EPDM  
Raccordement :  
DN80-150 : A brides PN10/PN16  
A partir DN200 : A brides PN16  
Pression de service max : 16 bar  
Température de service max : +80°C

Body, bonnet: Ductile Iron GGG40  
Filter: Stainless steel 316  
Standard Mesh: 2 mm  
Seal: EPDM  
Connection:  
DN80-150: Flanged PN10/PN16  
DN200-600: Flanged PN16  
Maximum Working pressure: 16 bar  
Maximum working temperature: +80°C

DN		L (mm)	Kg	Ref.
mm	inch			
80	3"	300	22	F4240-0080
100	4"	300	23	F4240-0100
125	5"	400	46	F4240-0125
150	6"	400	48	F4240-0150
200	8"	500	76	F4240-0200
250	10"	580	165	F4240-0250
300	12"	610	230	F4240-0300
350	14"	650	250	F4240-0350
400	16"	800	410	F4240-0400
450	18"	800	430	F4240-0450
500	20"	950	770	F4240-0500
600	24"	1100	850	F4240-0600



**Penser à monter une vanne de sectionnement en amont.  
Think about adding a block valve upstream.**



**Facilité de démontage par le chapeau, idéal sur les gros DN :**  
- en cas de problème d'encombrement  
- solution pour un nettoyage facilité  
**Easy disassembly with the bonnet, ideal for large DN :**  
- In case of a blockage problem  
- A solution for easy cleaning