

Ref. : CE 4252

Rev. : A

Date : 31/01/2018

Page : 1/1

COMPTEUR WOLTMANN A CADRAN SEC A BRIDES PN25

CE 4252



APPLICATION

Réseaux de distribution d'eau.

CARACTERISTIQUES GENERALES

Compteur individuel à très grande précision.
Installation horizontale.
Cadran sec.
Faible perte de charge.
Maintenance facile.

DIMENSIONS

DN	mm	50	65	80	100	125	150	200	250	300	400	500
	inch	2"	2"1/2"	3"	4"	5"	6"	8"	10"	12"	16"	20"
L		200	200	225	250	250	300	350	450	500	600	800
H		252	262	272	282	297	341	371	480	516	647	785

DEBITS

DN		Débit permanent Q3 (m3/h)	Débit maximum Q4 (m3/h)	Débit de transition Q2 (l/h)	Débit minimum Q1 (l/h)	Pression de service (bar)	Valeur minimale	Valeur maximale	Classe de température
mm	inch								
50	2"	40	50	800	500	25	0,5	999.999	T30/T50
65	2"1/2"	63	78,75	1260	788	25	0,5	999.999	T30/T50
80	3"	63	78,75	1260	788	25	0,5	999.999	T30/T50
100	4"	100	125	2000	1250	25	0,5	999.999	T30/T50
125	5"	160	200	3200	2000	25	0,5	999.999	T30/T50
150	6"	250	312	5000	3125	25	5	9.999.999	T30/T50
200	8"	400	500	8000	5000	25	5	9.999.999	T30/T50
250	10"	630	787,5	12600	7875	25	50	99.999.999	T30/T50
300	12"	1000	1250	20000	12500	25	50	99.999.999	T30/T50
400	16"	1600	2000	32000	20000	25	50	99.999.999	T30/T50
500	20"	2500	3125	50000	31250	25	50	99.999.999	T30/T50

CONDITIONS DE SERVICE

Pression de service maxi: 25 bar.

COURBE DE PRECISION TYPIQUE

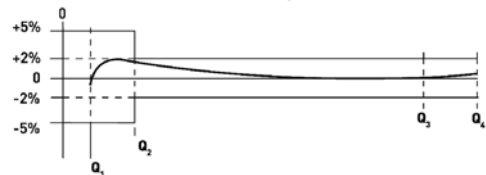

Classe métrologique MID (Q3/Q1) R=80

PERTES DE CHARGE

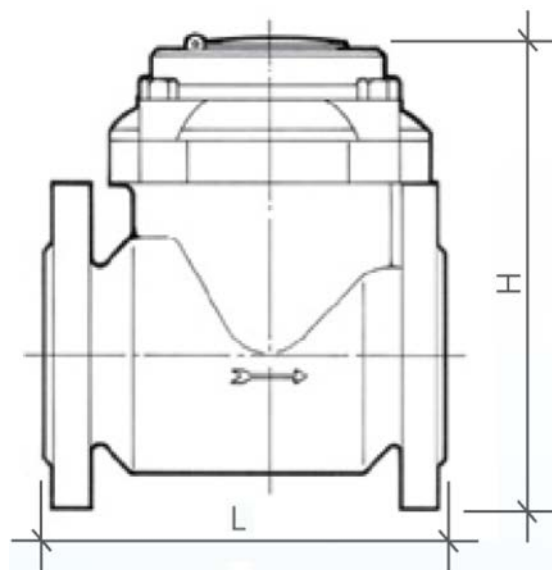
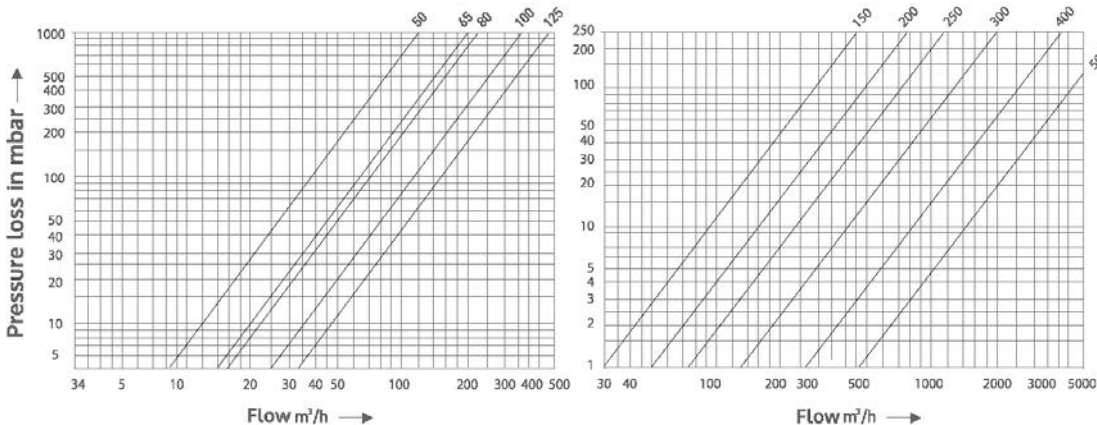

TECOFI France - 83, Rue Marcel Mérieux 69960 Corbas - FRANCE
Tél. +33 (0) 4 72 79 05 79 - Fax +33 (0) 4 78 90 19 19 / +33 (0) 4 72 79 05 70
Adresses e-mail : sales@tecofi.fr ; tecofi@tecofi.fr / Site web : www.tecofi.fr